

IRIDE.

dental furniture designed and made in **Italy**.





La nostra storia pg | 5-6
Our history

Perchè scegliere Iride?..... pg | 7-10
Why choosing Iride?

Laboratorio
Dental laboratorie

Linea classica
Classic line

serie EKO..... pg | 11-16

serie TEC..... pg | 17-20

serie 2000..... pg | 21-26

serie SKY..... pg | 27-30

serie MELISSA..... pg | 31-34

serie ELITE..... pg | 35-38

Linea contemporanea
Contemporary line

serie SESTO ELEMENTO..... pg | 39-44

Cad cam..... pg | 45-48
Cad cam

Sala gessi..... pg | 49-54
Plaster room

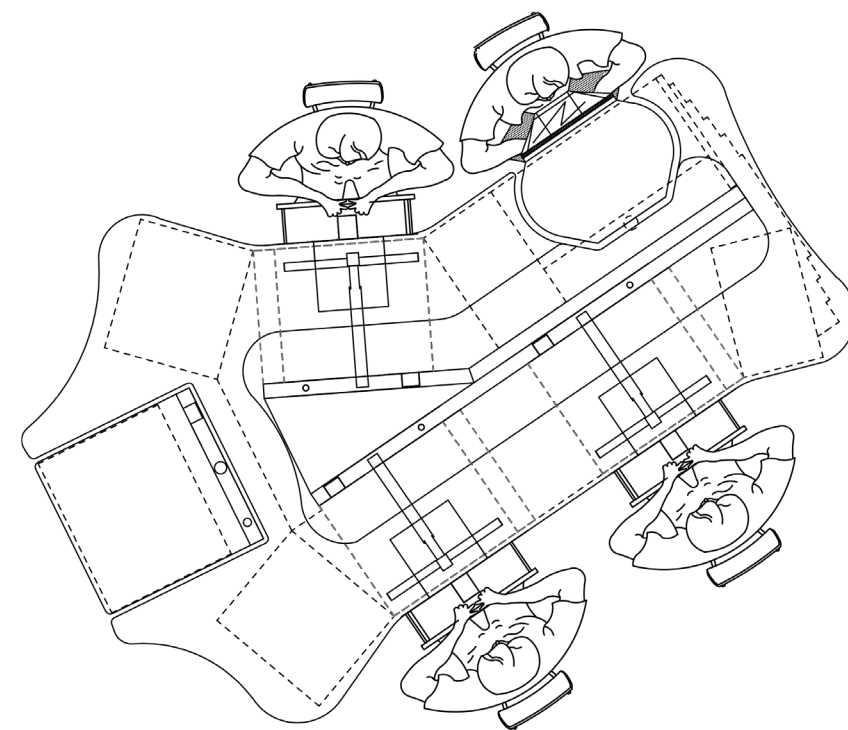

Accessori

Accessories

BOX.....pg | 55-56
Box

MINIBOX.....pg | 57-58
Minibox

CAPPETTA.....pg | 59-60
Cabinet for polishing machine.

CAPPA.....pg | 61-62
Fume cupboard

ASPIRAZIONI.....pg | 63-64
Suction system

RASTRELLIERA.....pg | 65-66
Rack

SEDIE E ACCESSORI POSTO LAVORO.....pg | 67-68
Chairs and workplace accessories

CUPOLA.....pg | 69-70
Cupola

LAMPADE.....pg | 71-74
Lamps

Personalizzazioni.....pg | 75-76
Customizations

Moduli.....pg | 77-94
Modules

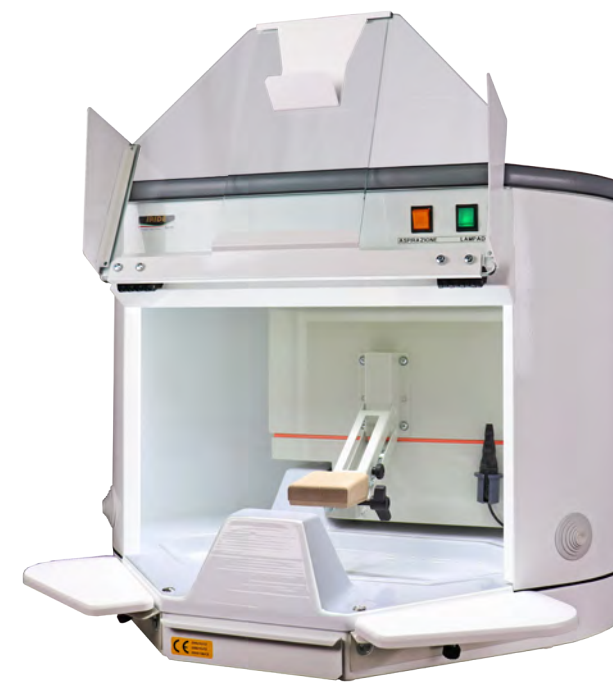

La nostra storia

Our history

IRIDE

Dal 1986 IRIDE international progetta e realizza arredamento e accessori, per studi odontoiatrici e laboratori odontotecnici.

Irìde International has been designing and manufacturing furniture and accessories for dental clinics and laboratories since 1986.



Le sue radici però, sono ben più profonde, infatti il suo fondatore e ideatore entrò già negli anni '70 nell'imprenditoria del settore dentale e, con la sua genialità ed inventiva brevettuale, il Sig. Enzo Tonin fondò "IRIDE".

Our tradition dates back to the 70', when Mr. Enzo Tonin started to work in the dental industry and thanks to his genius and creativity founded "IRIDE".

IRIDE manufactures innovative design furniture for dental clinics and laboratories. Several new series were designed to make your working life easier thanks to very high quality products and accessories.

IRIDE sviluppa linee innovative per studio e laboratorio. Nascono molte serie che migliorano e assecondano il metodo di lavoro dei professionisti del settore garantendo un altissima qualità nei prodotti.

1970

1986



Enzo Tonin fonda "IRIDE"

Mr. Enzo Tonin established "IRIDE"

1999



Our products are constantly improved, integrating new technologies and technical details which provide long service life, the highest levels of hygiene and easy cleaning. The Line series was designed in the '90s and it was meant to combine the qualities and the values of a family that does not stop to compromises.

I prodotti IRIDE vengono continuamente migliorati, integrando nuove tecnologie e dettagli tecnici che garantiscono una lunga durata, massima igiene e facilità di pulizia. In questi anni nasce Line, una serie che racchiude tutti questi concetti e i valori di una famiglia che non scende a compromessi.



2005



IRIDE sviluppa la serie Quadra dal design essenziale e pulito. Ogni dettaglio è sviluppato per garantire funzionalità, facilità di pulizia ed evitare che si formino depositi batterici. Quadra inoltre garantisce un'eccezionale versatilità e possibilità di personalizzazione da parte del cliente.

The Quadra series, created by IRIDE, is characterized by an essential and clean design. Every detail is meant to provide smart solutions, to avoid accumulation of bacteria and to improve easy cleaning. Moreover, Quadra is very adaptable and customers can easily personalize their own layout.

After the sudden and tragic death of Mr. Tonin in 2006, his heirs and staff, thanks to the strong tradition and inspired by the uniqueness of what the chief had established, continue to make IRIDE grow according to the values and the heritage of a far-sighted man...

Dopo la sua prematura e improvvisa scomparsa nell'anno 2006, i suoi eredi e tutto lo staff IRIDE, forti delle sue radici e motivati da quanto di così unico aveva creato il sig. Enzo continuano tutt'ora a crescere e a far crescere IRIDE secondo valori e tradizioni di un tempo e di un uomo che sapeva vedere oltre...

illuminazione a led-rgb

LED-RGB lighting



2014

L'innovazione continua...

Innovating new products

Nasce EX-L, una linea innovativa che integra design e facilità d'utilizzo. La forma dei frontali infatti permette l'apertura dei cassetti senza l'aggiunta di maniglie o sistemi elettromeccanici. La forma diventa funzione. Irìde designed EX-L, an innovative series which combines style and handiness. The fronts are made in order to allow the opening of the drawers without handles or any electro-mechanical systems. Form becomes function.

Fly is the latest development in LED lights for dental work benches: aluminium frame, innovative design and attention to details. Fly, our innovative lamp, can be easily adjusted in several positions according to your needs. It is a valuable accessory for dental workplaces.

Nasce FLY, l'ultima evoluzione dell'illuminazione a LED per i banchi da laboratorio. Completamente in alluminio, un design innovativo curato in ogni dettaglio. FLY si plasma a seconda delle esigenze dell'utente offrendo infinite regolazioni di movimento e d'intensità di luce. Un nuovo riferimento per il settore dentale.

2017

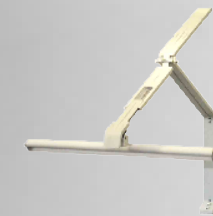

IRIDE continua a crescere e sviluppare soluzioni all'avanguardia. Porta avanti forti legami con il territorio, garantendo un prodotto realizzato da maestranze italiane, per offrire ai nostri clienti la qualità di un prodotto 100% made in Italy. IRIDE is constantly increasing its business and developing pioneering solutions. Our products are 100% Made in Italy, manufactured by local craftsmen in order to carry on strong ties with the territory.

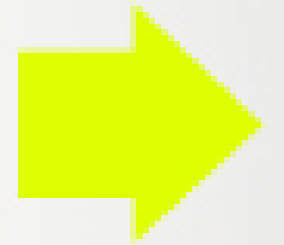

Perchè scegliere Iride?

Why choosing Iride?

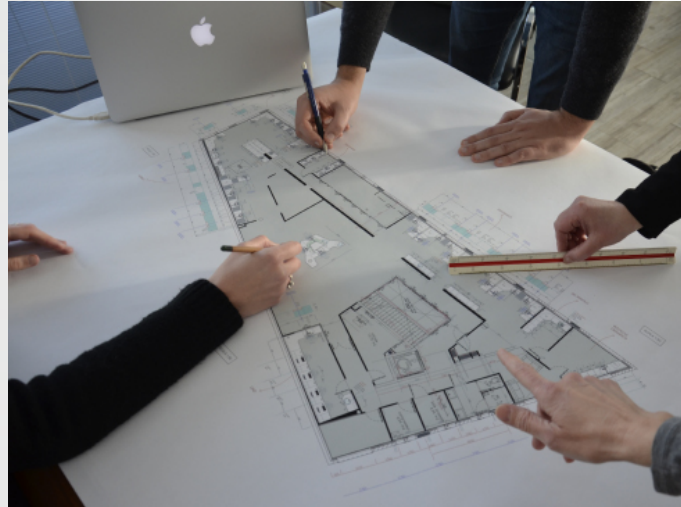
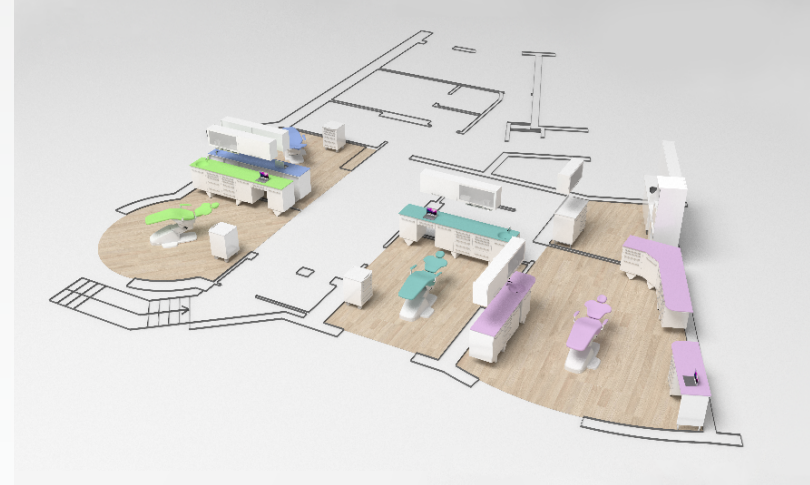

Sviluppiamo il tuo progetto

I progettisti IRIDE analizzeranno le tue esigenze e ti affiancheranno durante tutte le fasi di sviluppo del progetto. Dallo schizzo di studio iniziale al disegno delle piante, un team composto da architetti e designer ti aiuterà nello sviluppo dei singoli componenti fino alla definizione di ambienti completi. Verificheremo insieme a te ogni dettaglio, materiale, colore e potrai visualizzare l'anteprima fotorealistica del tuo progetto.

We develop your project

Our designers will study your demands and double check them with you while your project is being outlined: a team of architects and designers will help you draw your working space: from sketches and plans, from the development of single components to the designing of whole rooms. We check every detail with our customers (materials, colours) and we offer photorealistic previews.

Realizziamo i nostri prodotti a partire dalla materia prima

Scegliamo accuratamente i fornitori di materie prime e le controlliamo attentamente prima che entrino nel ciclo produttivo. Utilizziamo lamiere elettrozincate e la tecnica della rivettatura per mantenerne le proprietà. I nostri tecnici specializzati, partendo dalla materia prima, realizzano le scocche e i componenti dei mobili garantendo un'altissima qualità dei semilavorati e la possibilità di realizzare componenti ed ambienti su misura delle tue esigenze. Riusciamo così a controllare ogni fase della realizzazione ed assicurare ai nostri clienti un prodotto che dura nel tempo.

Our products are manufactured starting from raw materials.

We carefully screen our raw material suppliers and we accurately check the materials before using them in the production cycle. We use electro galvanized steel sheets and riveting to preserve their characteristics. Our specialised technicians produce shells and furniture components starting from raw materials, in order to guarantee high quality semi-finished products, and the possibility of manufacturing components and furnishing your rooms according to your needs. This way we manage to check every manufacturing step, in order to offer long lasting products.

Perchè scegliere Iride?

Why choosing Iride?

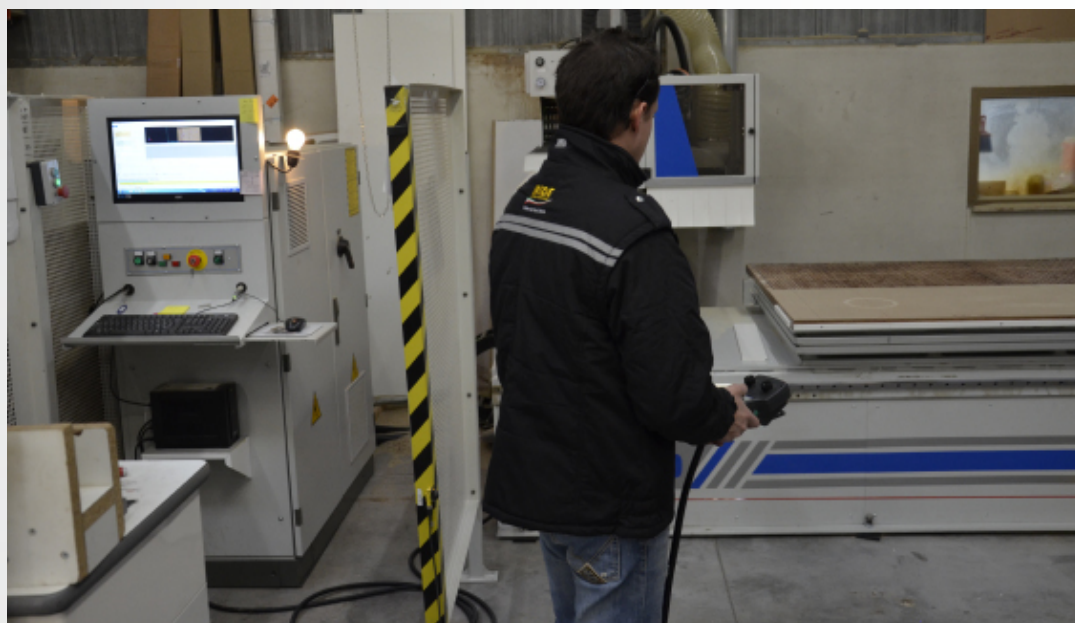

Qualità 100 % made in Italy

IRIDE porta avanti forti legami con il territorio. Garantiamo un prodotto realizzato da maestranze italiane, per offrirti una qualità 100% made in Italy. A partire dal design, studiato dai nostri progettisti per ridurre l'insorgere dei batteri, facilitare la pulizia e durare nel tempo, ogni fase di lavorazione viene eseguita all'interno dell'azienda: dalla creazione dei componenti, alla verniciatura fino al pre-montaggio del progetto. In questo modo riusciamo a controllare ogni dettaglio del prodotto e realizzare progetti su misura delle tue necessità.

Quality 100 % made in Italy

IRIDE established close business relationships with local craftsmen to supply high quality standards and 100% made in Italy products. Our furniture is designed to minimize bacterial growth, make cleaning easier and last for a long time; every manufacturing step is carried out at our premises: from component production and painting to pre-assembly. In this way we can check every detail and we can supply customized products.

Collaudiamo il tuo prodotto prima della consegna

I prodotti IRIDE sono concepiti dai nostri progettisti e realizzati in azienda per durare nel tempo, garantire massimi livelli d'igiene e facilità di pulizia. I tecnici IRIDE infatti realizzano un primo montaggio dei mobili all'interno dello stabilimento, verificano l'idoneità dei componenti, collaudano il corretto funzionamento e approvano il prodotto. In questo modo garantiamo l'alta qualità dei nostri mobili, che nascono e vengono realizzati interamente all'interno dell'azienda.

Our goods are tested before we despatch them

Our products are created by our designers and manufactured at our premises to guarantee long service life, the highest levels of hygiene and easy cleaning. Our technicians assemble them in our workshops, they make sure that the components are suitable, they check that each product works properly and they give their final approval. That's how we are able to supply very high quality goods that are entirely designed and manufactured in our premises.

Eko La risposta ad ogni esigenza

The answer to all your needs

Eko è la nostra serie tradizionale, adatta a chi ricerca l'essenziale, senza rinunciare alla funzionalità
Eko is our traditional series, designed for those who are looking for the essential, without giving up functionality

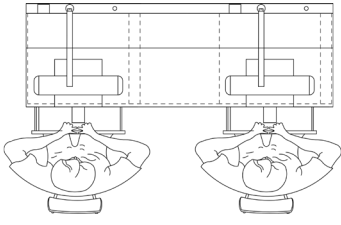

L 1940mm
P 652mm
H 900mm

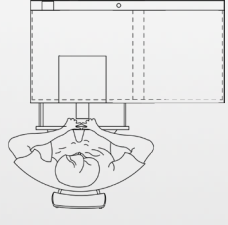

L 1230mm
P 652mm
H 900mm

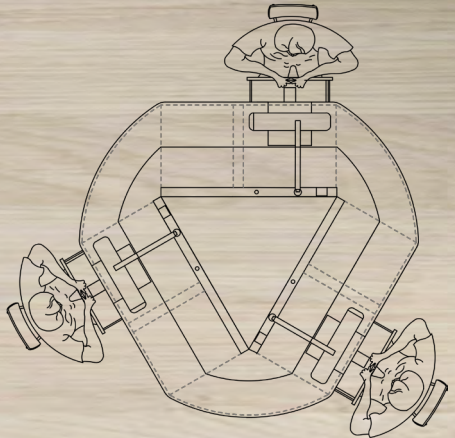

L 2340mm
P 2170mm
H 900mm

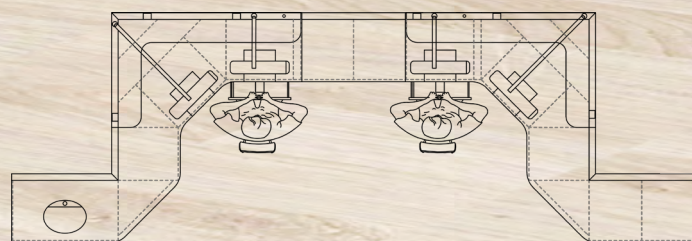

L 6480mm
P 2170mm
H 900mm

Tec Più comodità ed efficienza nel lavoro di ogni giorno

More comfort and efficiency in everyday's work

Tec incorpora la tradizione della serie Eko e la novità d'essere posta su telaio
Tec incorporates the Eko series's tradition and the innovation of being placed on a frame

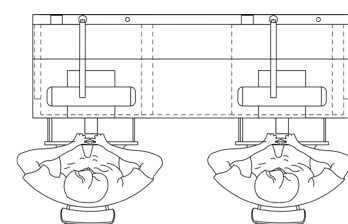

L 2020mm
P 652mm
H 900/950mm

pg | 17-18

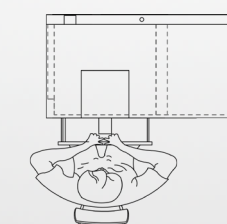

L 1270mm
P 652mm
H 900/950mm

linea classica

Tec

IRIDE.

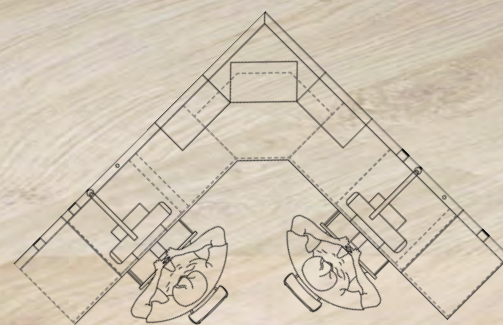

L 2640mm
P 2640mm
H 900/950mm

2000 Design che sfida il tempo

Design that defies time

2000 è la nostra serie morbida: i cassetti arrotondati promettono un comfort assoluto

2000 is our soft series: the rounded drawers promise absolute comfort

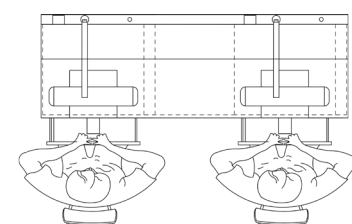

L 1980mm
P 652mm
H 900mm

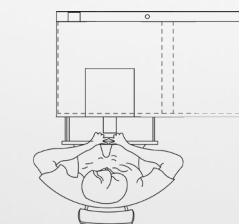

L 1250mm
P 652mm
H 900mm

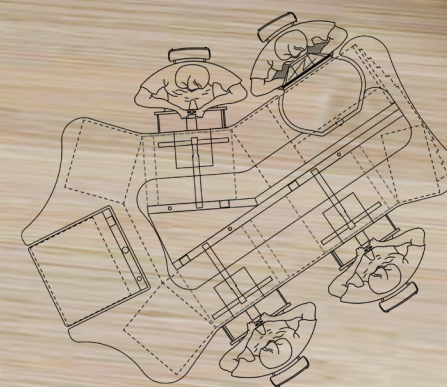

L 3350mm
P 2300mm
H 900mm

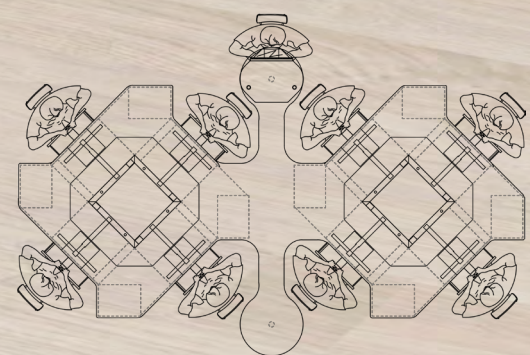

L 5620mm
P 3420mm
H 900mm

Sky Funzionalità inarrivabile

Invaluable functionality

Sky incorpora la tradizione della serie 2000 e la novità d'essere posta su telaio
 Sky incorporates the 2000 series' tradition and the innovation of being placed on a frame

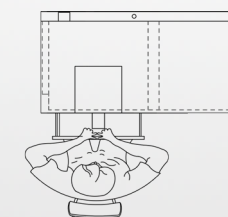

L 1290mm
 P 652mm
 H 900/950mm

linea classica

IRIDE.

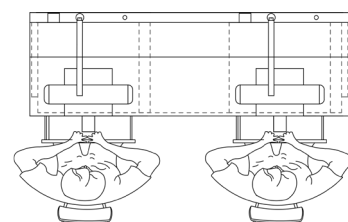

L 2060mm
 P 652mm
 H 900/950mm

pg | 27-28

Sky

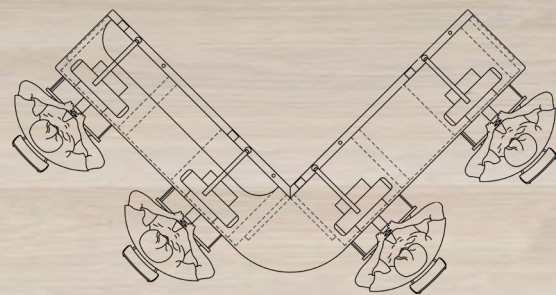

L 3730mm
P 2120mm
H 900/950mm

Melissa Adatta alle tue esigenze

Suitable to your needs

Melissa racchiude in sé tutta l'accessorialità e comodità di cui hai bisogno

Melissa includes all the accessories and comfort you need

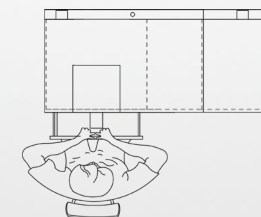
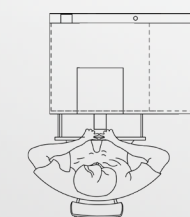

L 1010mm
P 652mm
H 900mm

L 1510mm
P 652mm
H 900mm

linea classica

IRIDE.

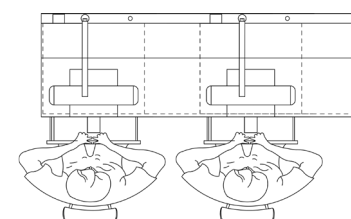

L 2000mm
P 652mm
H 900mm

Melissa

pg | 31-32

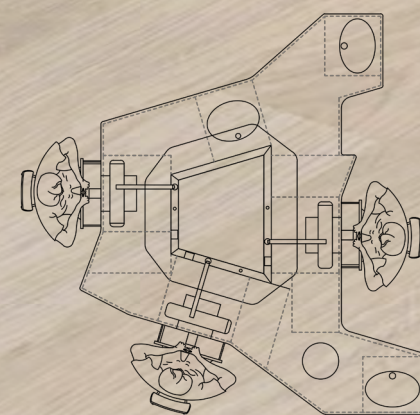

L 2900mm
P 3370mm
H 900mm

Elite La completezza

The completeness

Elite è, da sempre, la nostra pupilla. Qui, design, comfort e accessorietà si fondono insieme nella tua area di lavoro
Elite has always been our favourite one. Here, design, comfort and accessories come together in your working area

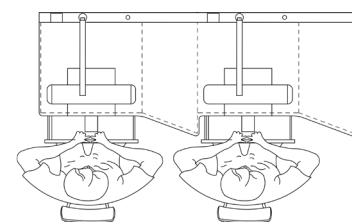

L 2000mm
 P 652mm
 H 900mm

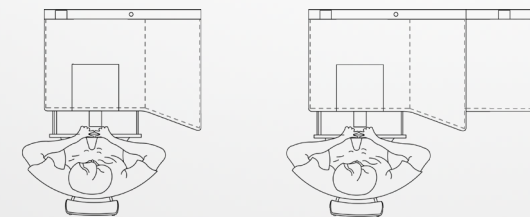

L 1010mm
 P 652mm
 H 900mm

L 1510mm
 P 652mm
 H 900mm



L 3800mm
P 1480mm
H 900mm

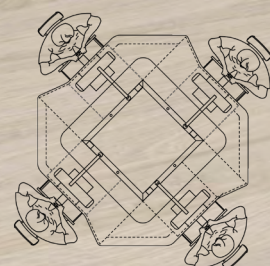
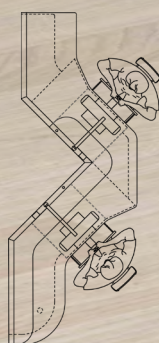

L 2430mm
P 2430mm
H 900mm

Elite

pg | 37-38

linea classica

IRIDE.

Sesto elemento L'evoluzione

The evolution

Il Sesto elemento è la fusione di forma e passione. È l'evoluzione di un mobile che, con le sue linee eleganti ed innovative, racchiude il cuore pulsante del banco

Sesto elemento is the fusion of form and passion. It is the evolution of a furniture which, thanks to its elegant and innovative lines, holds the beating heart of the work table

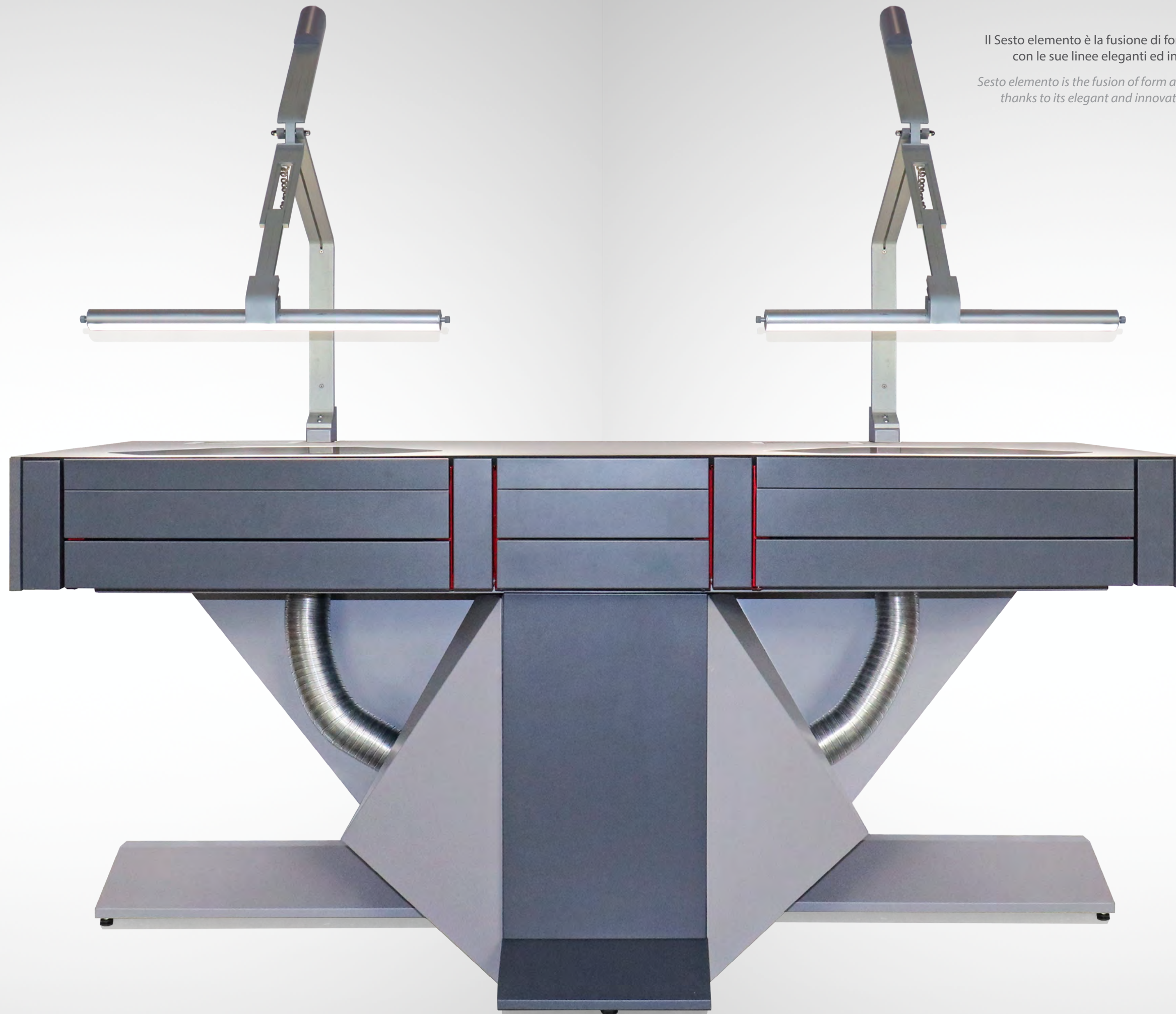

L 1950mm
P 650mm
H 950mm

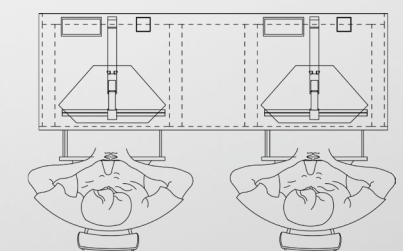

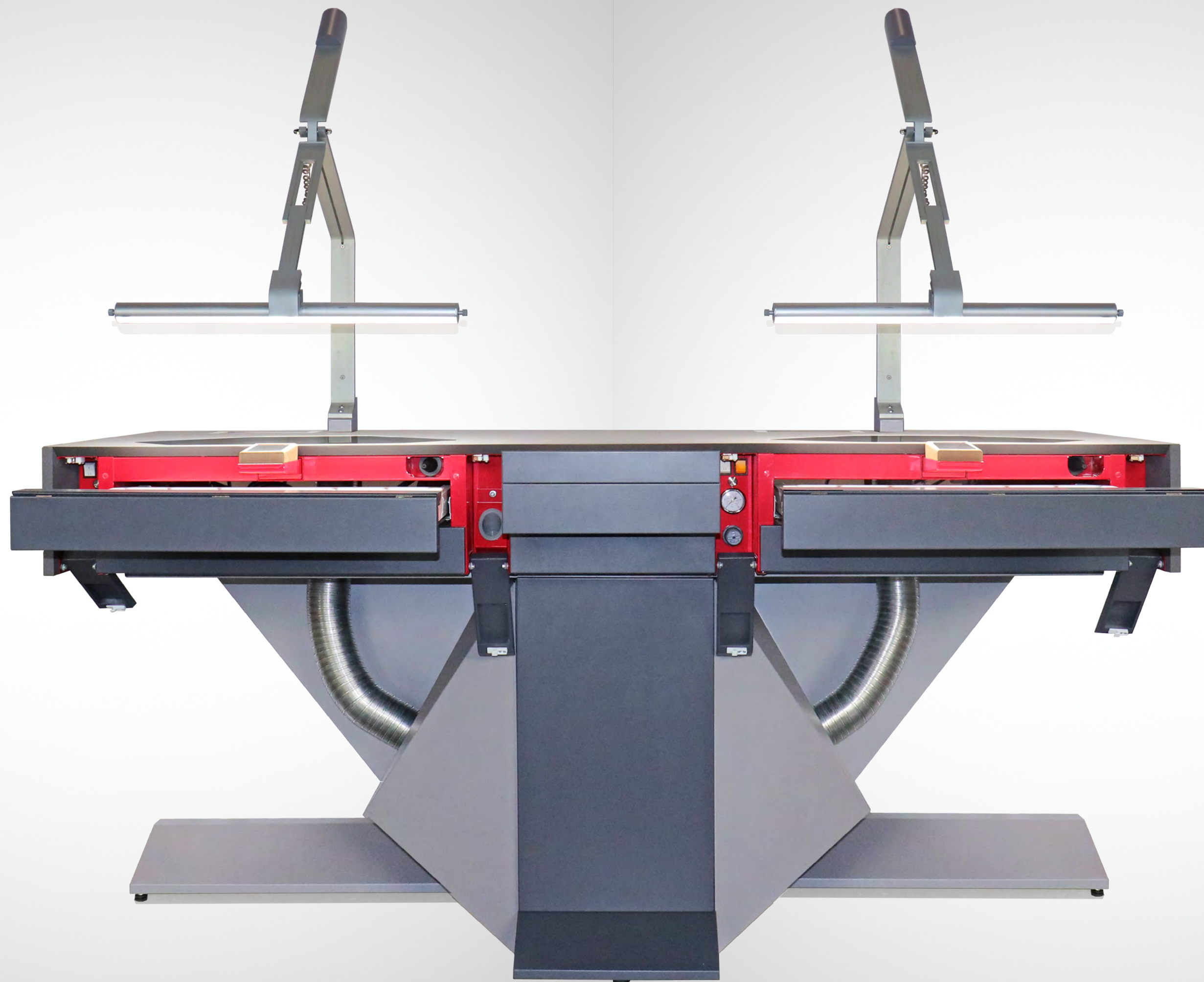

Mahmood, Sfera Ebbasta, Feid - Dorado



Abbiamo il piacere di presentarvi l'apparizione del SESTO ELEMENTO, una delle nostre più soddisfacenti creazioni, nel video "Dorado", brano di successo dei rapper Mahmood, Sfera Ebbasta e Feid. Se non l'avete ancora fatto, vi invitiamo ad andare a guardarlo su YouTube!

We are pleased to present you the appearance of the SESTO ELEMENTO, one of our most satisfying creations, in the video "Dorado", a hit song by the rappers Mahmood, Sfera Ebbasta e Feid. If you haven't already done so, we invite you to go and watch it on YouTube!



vevo

▶ ⏪ 🔊 1:45 / 2:58



Cad-Cam II design che segue l'innovazione

Design that chases innovation

Le nostre postazioni Cad-Cam sono progettate e costruite attorno alle tue esigenze, per garantirti il massimo comfort. Sono, quindi, componibili e personalizzabili nelle soluzioni

Our Cad-Cam workstations are designed and built around your needs, in order to guarantee maximum comfort. They are, indeed, combinable and customizable in solutions

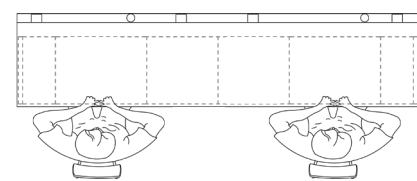

L 2820mm
P 652mm
H 832mm

pg | 45-46

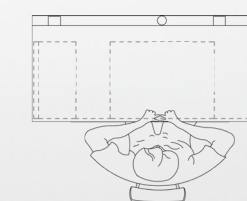
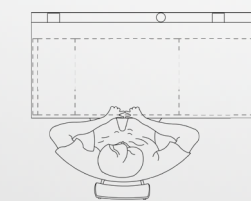

L 1420mm
P 652mm
H 832mm

L 1420mm
P 652mm
H 832mm

linea classica

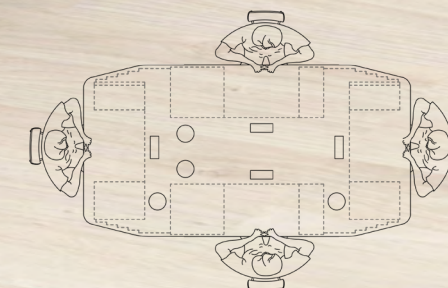

L 3050mm
P 1600mm
H 900mm

Sala gessi su misura di ogni spazio

Tailored to any space

La versatilità senza confini delle nostre sale gessi, ti permette di spaziare con la creatività. Non importa di quale spazio disponi, i progettisti Iride ti aiuteranno a configurare una sala gessi su misura delle tue esigenze

The boundless versatility of our plaster rooms allows you to range with creativity. No matter what kind of space you have, Iride designers will help you depicting a plaster room tailored to your needs

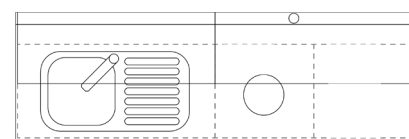

L 2020mm
P 652mm
H 900mm

Sala Gessi

pg | 49-50



L 2020mm
P 652mm
H 910mm

linea classica

IRIDE.



Sala gessi

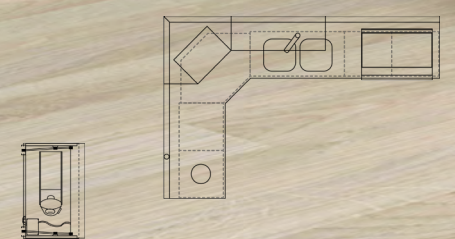

LATO CORTO 1925mm
LATO LUNGO 2925mm
P 652mm
H 950mm

pg | 51-52

linea classica

CAPPA
L 1200mm
P 800mm
H 2110mm

CAPPETTA
L 750mm
P 520mm
H 585mm

IRIDE.

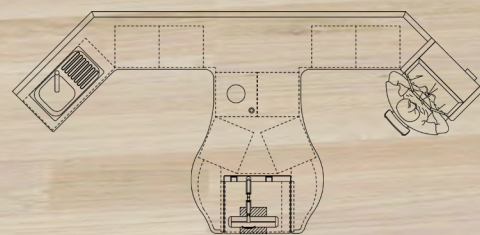

L 5350mm
P 2500mm
H 1000mm

BOX Finitura sottovetro

Refinement under glass

Con il nostro Box, sicurezza e salute sono garantite: grazie al sistema sottovetro, tutti i componenti nocivi liberati dalle lavorazioni vengono convogliati da un motore ad induzione, e raccolti in un apposito filtro intercambiabile

With our Box, safety and health are guaranteed: thanks to the under glass system, all the noxious components released while working, are conducted by an induction motor and collected in a specific interchangeable cleaner

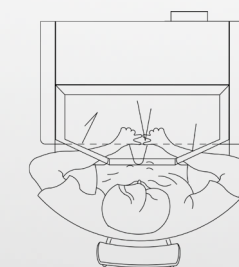

L 840mm
H 1330mm
P 670mm

Minibox Ritocchi finali

Final adjustments

Più compatto rispetto al Box, il Minibox è un accessorio indispensabile per chi ricerca la perfezione: è uno strumento versatile e utile per i ritocchi finali

More compact than the Box, the Minibox is an essential accessory for those who are looking for perfection: it is a versatile and useful tool for final adjustments



TAVOLINO FISSO
L 730
P 650mm
H 840

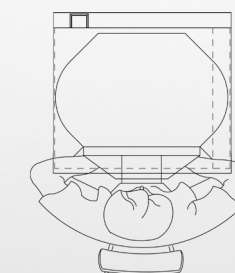
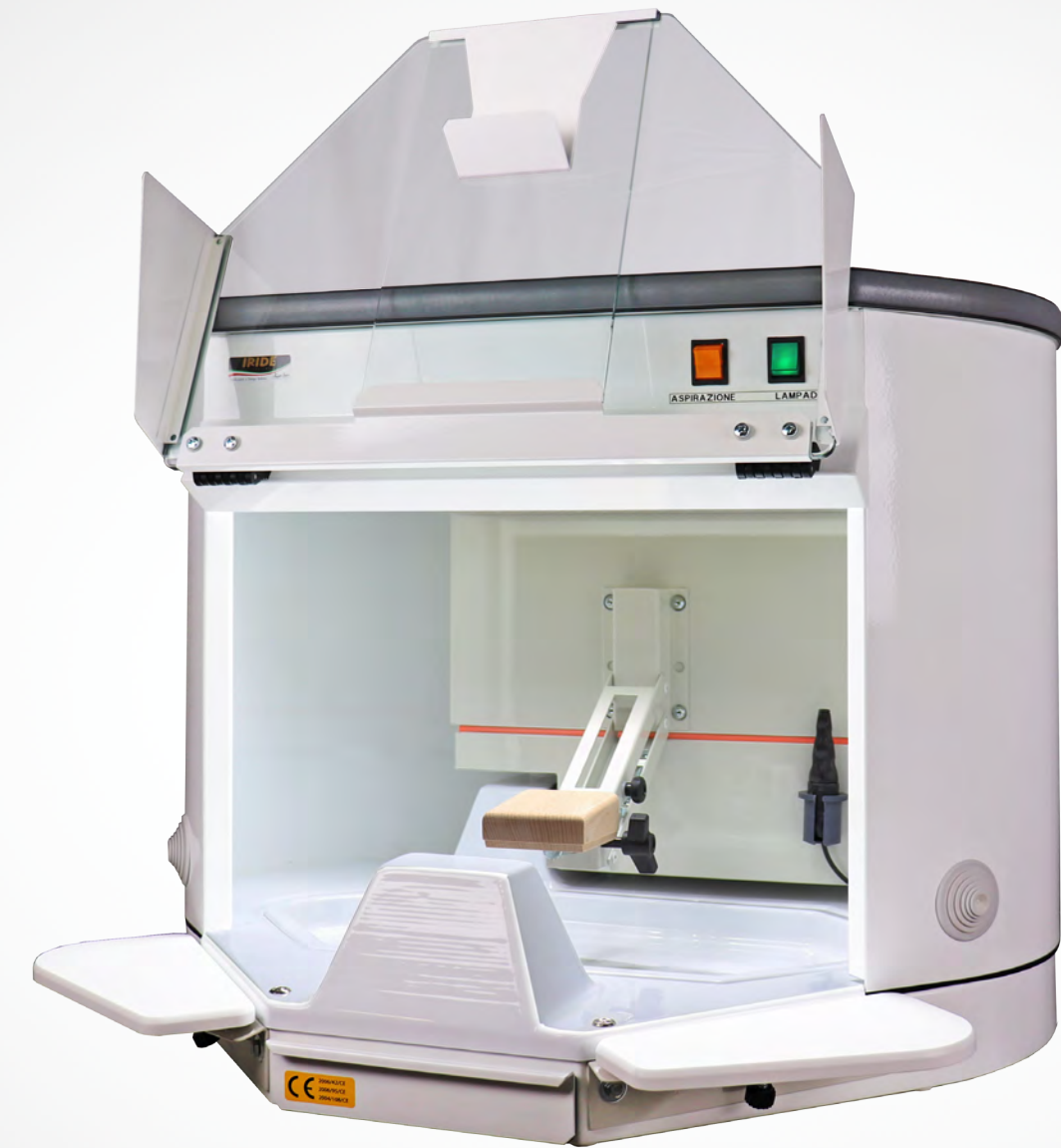

MINIBOX
L 710mm
P 620mm
H 550mm



TAVOLO SALISCENDI
L 750mm
P 652mm
H 1150mm

Cappetta Aspirante per pulitrice *Suction cleaner*

Accessorio indispensabile per eseguire lavori di lucidatura; disponibile sia nella versione classica, sia nella versione completamente in acciaio inox. Il tavolo saliscendi garantisce il massimo comfort durante l'utilizzo

Essential accessory for polishing works; available in the classic and in the completely stainless steel version. During its use, maximum comfort is guaranteed by an adjustable table

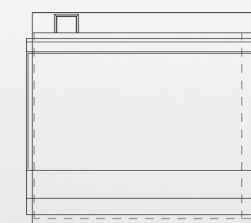

L 750mm
P 520mm
H 585mm

Cappa aspirante Un must per il tuo laboratorio

Must have for your laboratory

Da sempre il nostro fiore all'occhiello. La solidità è una garanzia del suo funzionamento a lunga durata. Studiata nei minimi dettagli. Disponibile in numerose versioni

Our flagship since the beginning. Solidity is a guarantee of its long-lasting functioning. Studied in its every smallest detail. Available in many versions

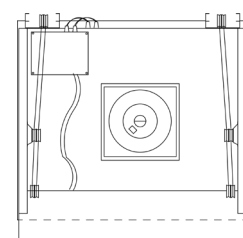

L 810mm
P 800mm
H 2110mm

Cappa

pg | 61-62

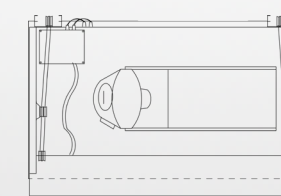

L 1210mm
P 800mm
H 2110mm

linea classica

IRIDE.

Aspirazione Singola o doppia

Single or double

Potente, silenziosa, dotata di motore ad induzione. Studiata per adattarsi a tutte le nostre linee da laboratorio
Powerful, silent, equipped with an induction motor. Designed to conform to all our laboratory lines



RASTRELLIERA

Rack

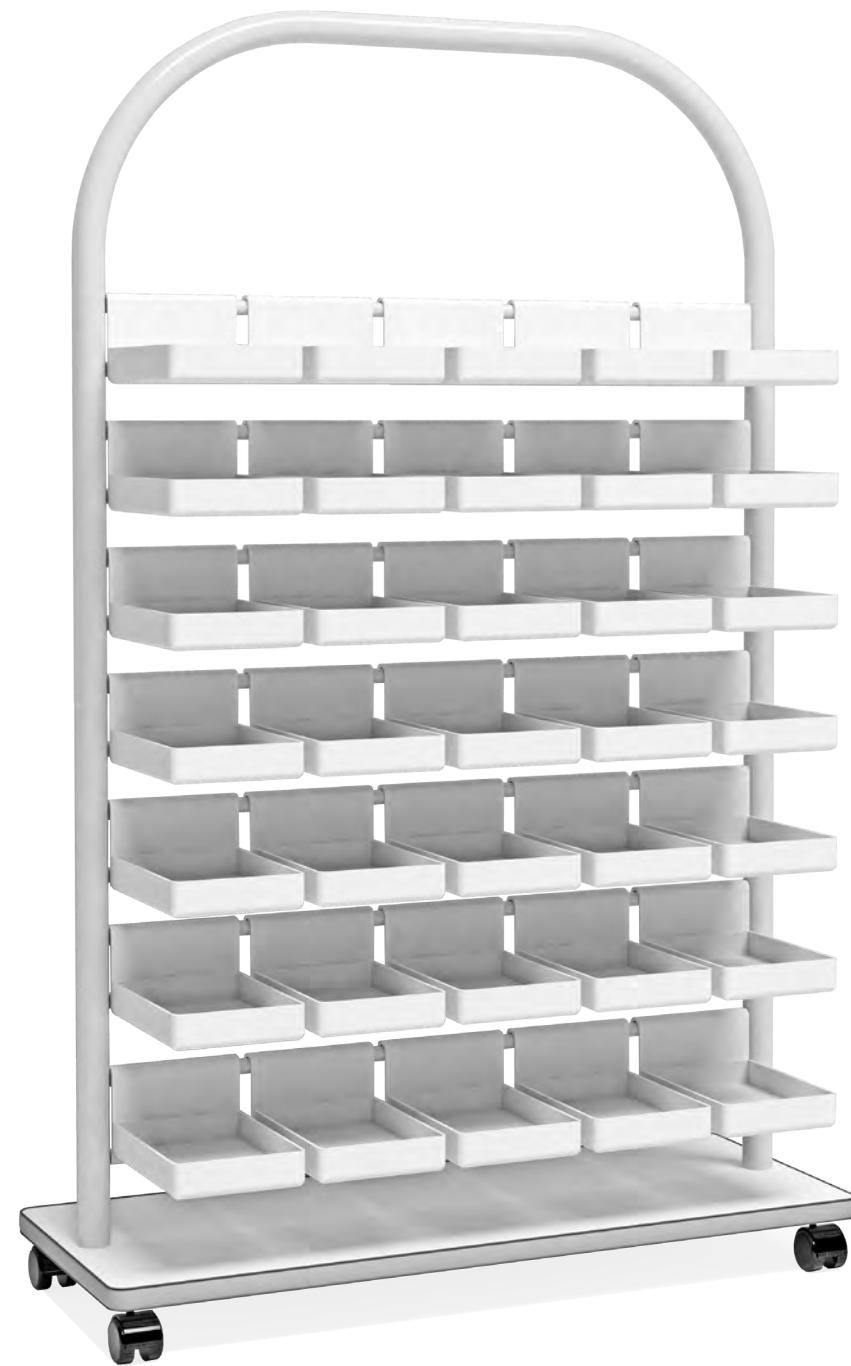

L1040mm
P400mm
H1700mm

Rastrelliera

pg | 65-66

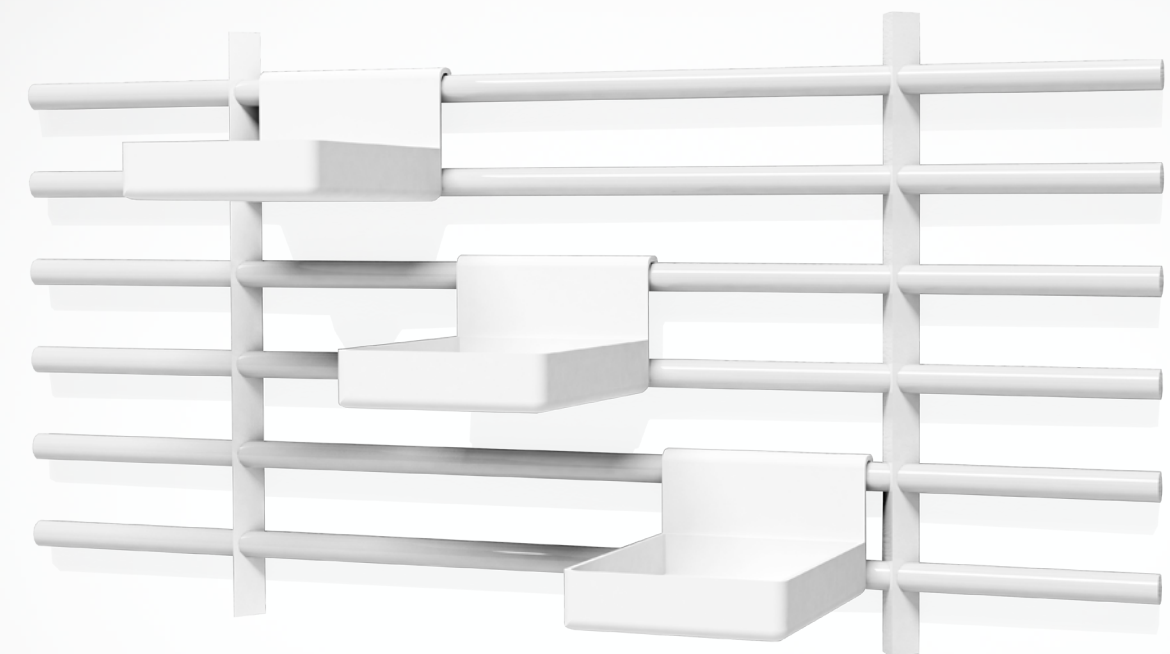

L1000/1500mm
H500mm

linea classica

IRIDE.

SEDIE
Chairs



Basamento in alluminio
Aluminum base



Basamento nero
Black base

ACCESSORI PER POSTAZIONE LAVORO
Workplace accessories

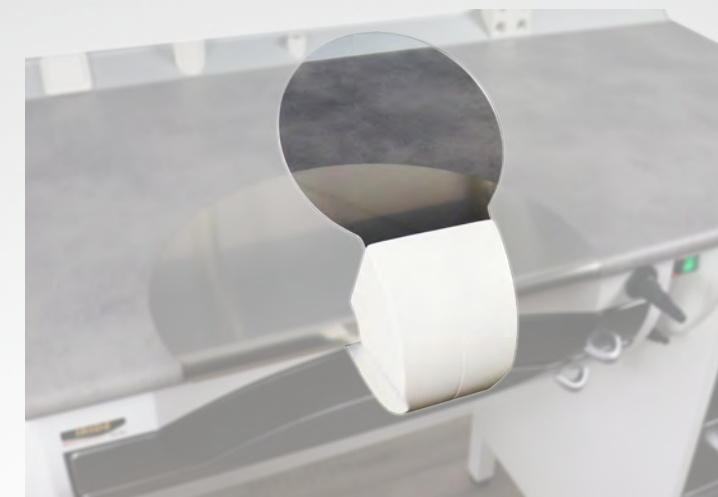

Conchiglia
Conchiglia



Vetro regolabile per zeppa
Adjustable glass for peg

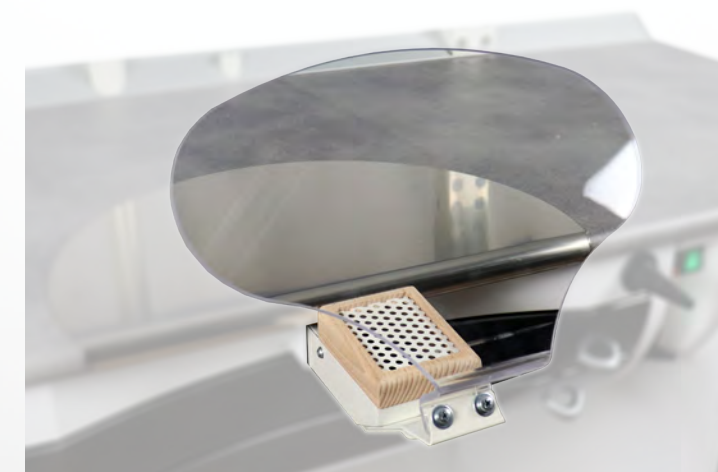

Nuvola
Nuvola

CUPOLA CON LUCE E SENZA LUCE

Cupola with and without light

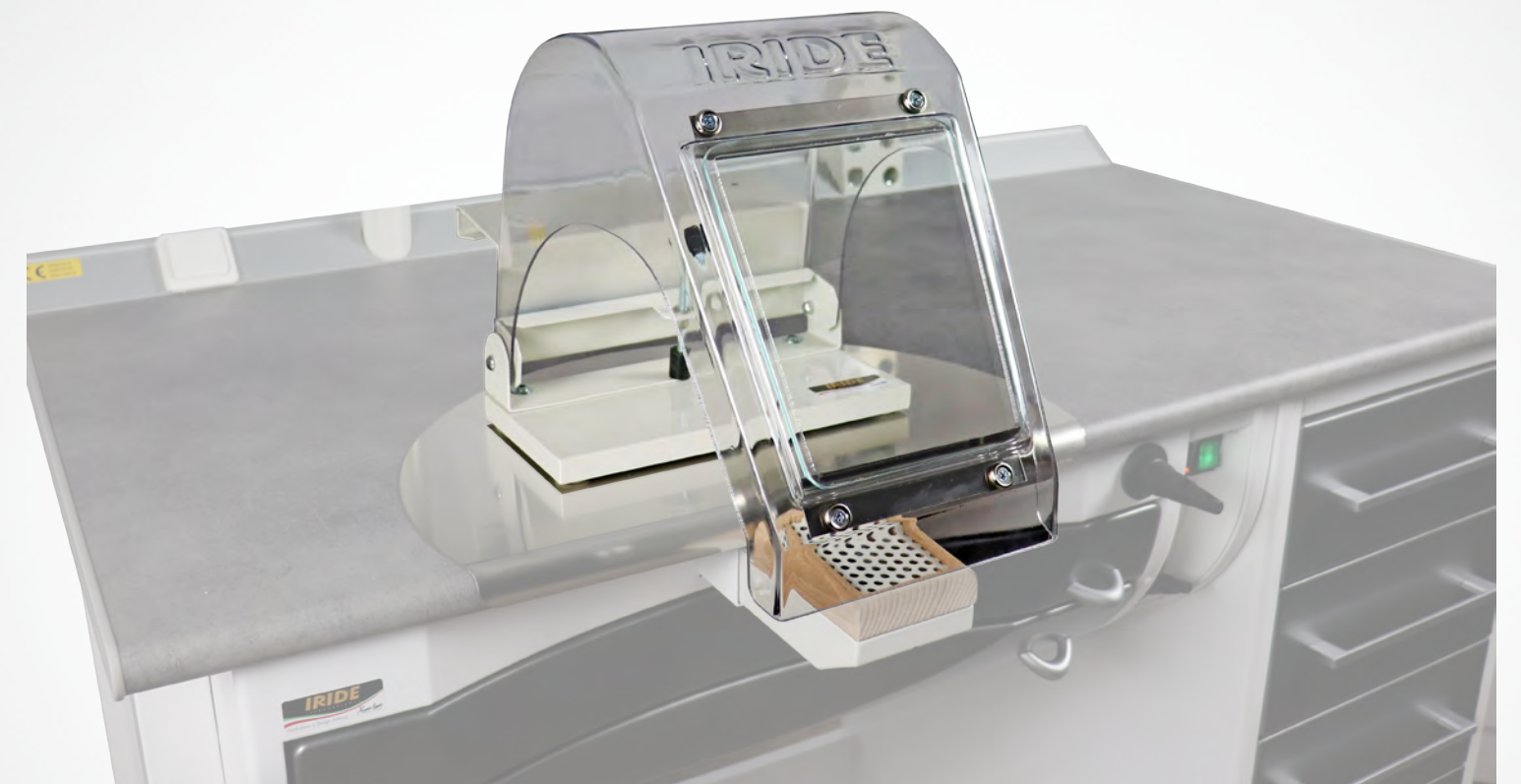
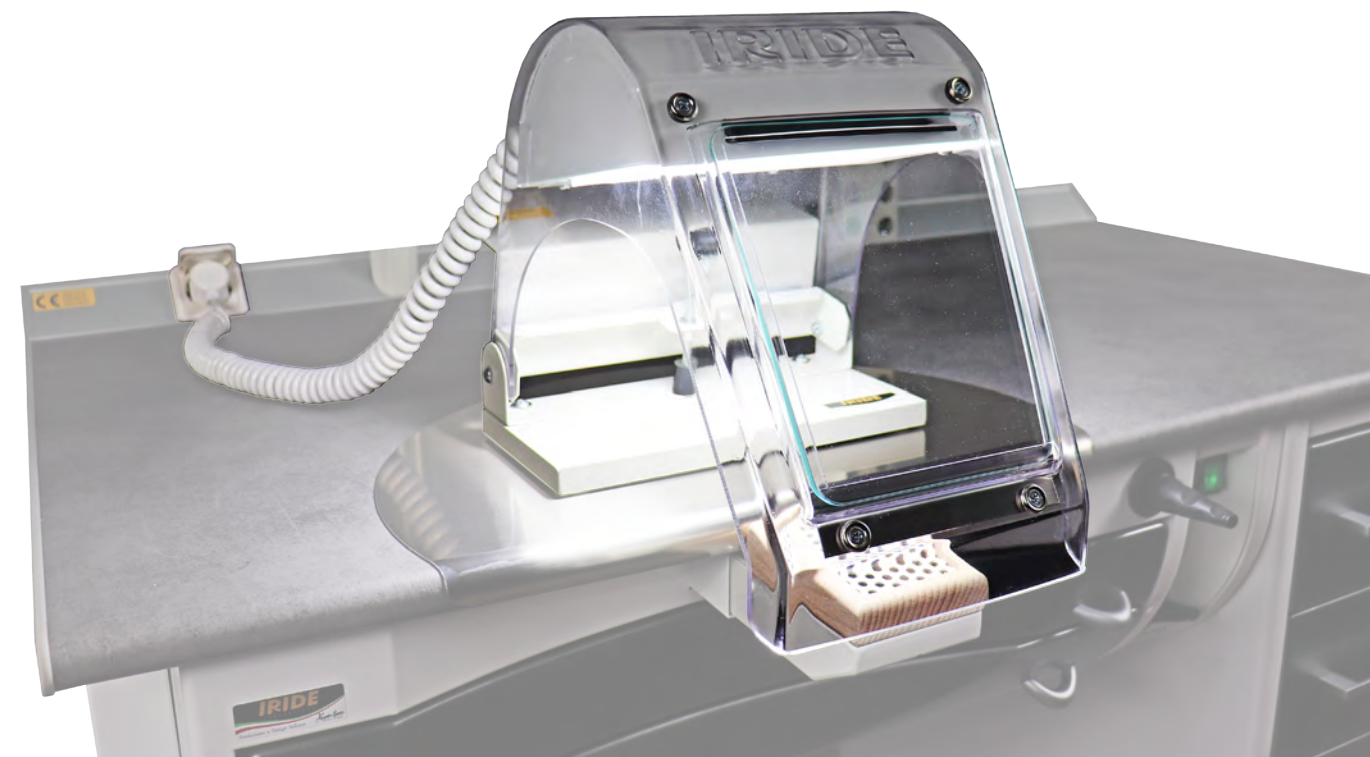

Lampada saliscendi

La nostra classica lampada saliscendi è provvista di un braccio che include tre punti di snodo; questo permette una totale libertà di movimento in tutte le direzioni. Disponibile in versione neon o led (dimmerabile)

Our classic sliding lamp is equipped with an arm which includes three meeting points; this allows total freedom of movement in every direction. Available in neon or led version (dimnable)

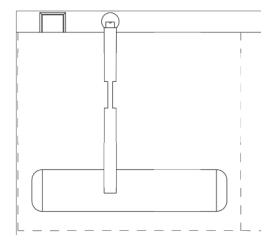

Lampada fissa

La nostra lampada fissa ha una peculiarità: uno snodo all'estremità del braccio permette una parziale regolazione in altezza. Disponibile in versione neon o led (dimmerabile)

Our fixed lamp has a peculiarity: a ball joint at the far end of the arm, which allows partial height adjustment. Available in neon or led version (dimnable)

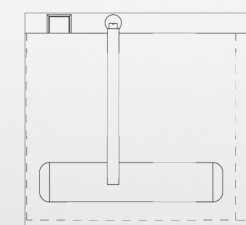

Lampada Fly

Una luce unica. Fly è l'ultima evoluzione dell'illuminazione; un design innovativo curato in ogni dettaglio.
Offre infinite possibilità di regolazione di movimento e intensità di luce

*A unique light. Fly is the latest illumination's evolution; an innovative design studied in each detail.
It offers unlimited possibilities regarding regulation of movement and intensity of light*

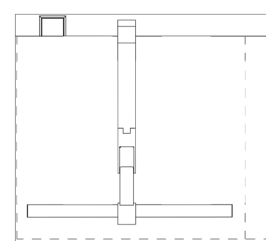

Lampada basic

Illuminazione adatta a chi è alla ricerca dell'essenziale, ma non rinuncia alla funzionalità
Illumination suitable for those who are looking for the essential, not giving up functionality

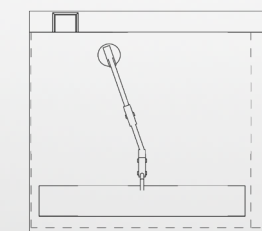

Personalizzazioni

Customizations

Colori, vetri, maniglie e materiali, scegli tra le molte opzioni disponibili e personalizza la tua composizione come hai sempre sognato!

Colours, glass, handles and materials: choose among many available options and customize your composition as you have always dreamed of!

colori RAL classic/RAL classic colours



colori speciali /special colours



materiali/materials

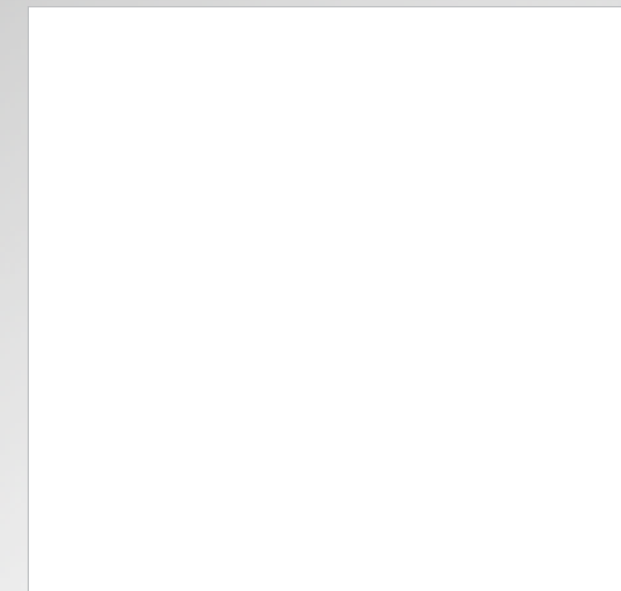

bianco

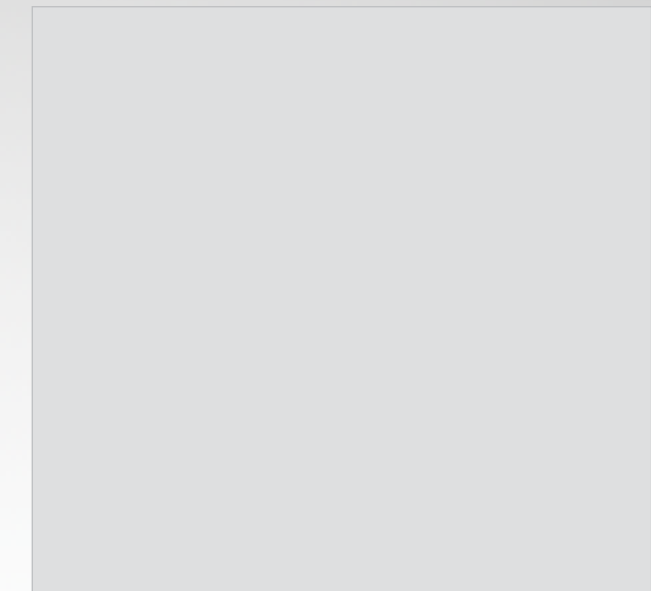

grigio chiaro



rovere chene



copperfield

maniglie/handles



luna



sheila



moby

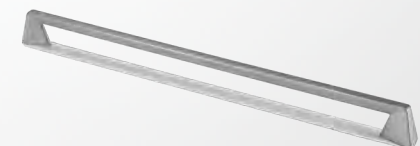

prince

Nel catalogo le tonalità di colore dei prodotti potrebbero risultare leggermente diverse dall'originale. I riferimenti RAL associati ai mobili sono quindi da considerarsi indicativi.

In the catalogue, the color shades of the products may be slightly different from the original. The RAL references associated with the furniture are therefore to be considered indicative.

BANCHI

P 650 H filo piano 905 H filo alzatina 945
 P 650 H above top 905 H above channel 945



BLM
L. 660



BLM 1
L. 730



BLM 1 -CM 2
L.1230



BLM 101
L. 1230

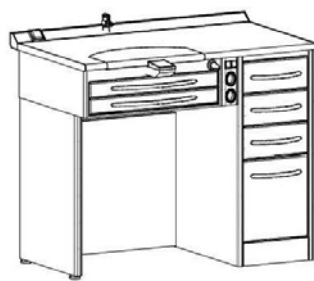

BLM 101 -35
L. 1080

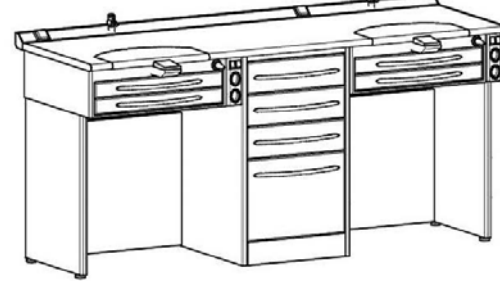

BLM 201
L. 1940

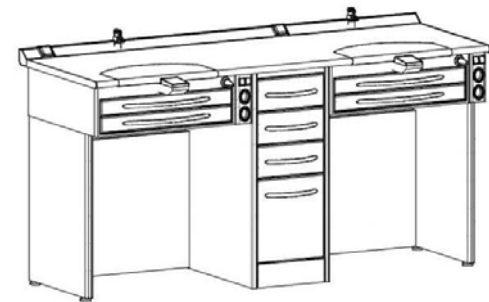

BLM 201 -35
L. 1790

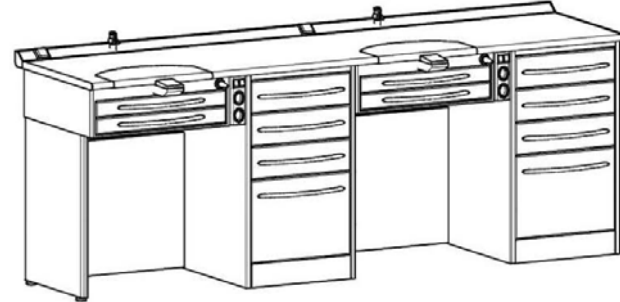

BLM 301
L. 2440

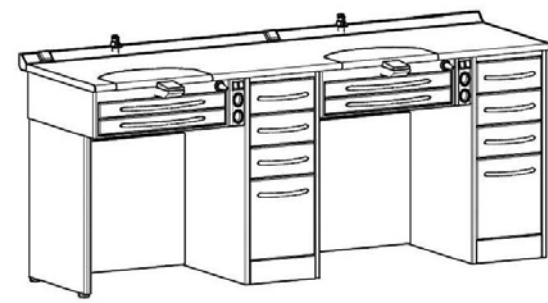

BLM 301 -35
L. 2140

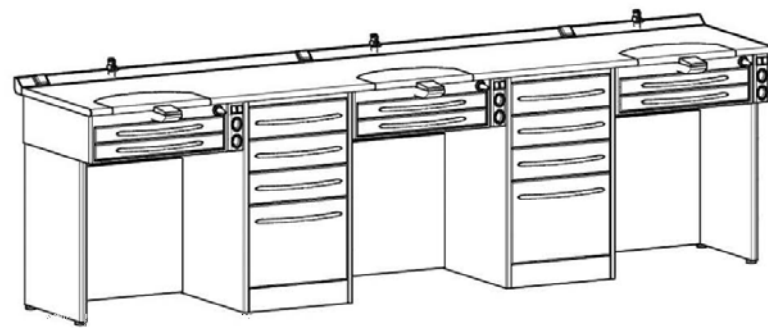

BLM 303
L. 3150

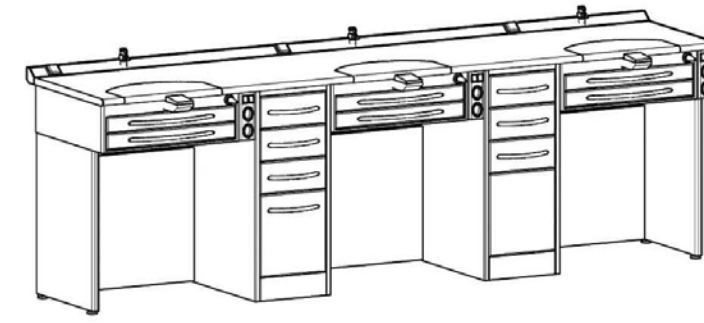

BLM 303 -35
L. 2850

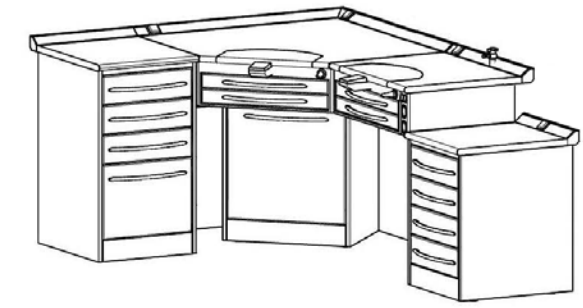

BLM -CER
L. 1590/2300

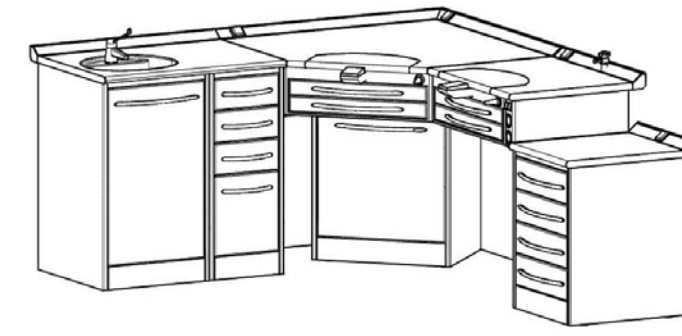

BLM -CER 1
L. 1940/2300



BLMA
L. 1080/1080

CASSETTIERE

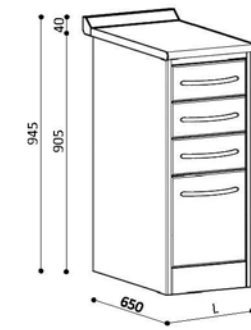

CM 1 -35
L. 370

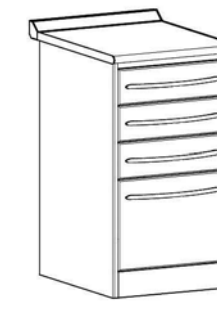

CM 1 -50
L. 520

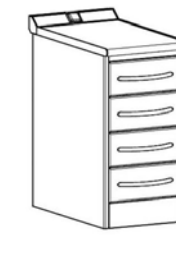

CM 2 -35
L. 370 H. 700



CM 2 -50
L. 520 H. 700



CM 3 -50
L. 520

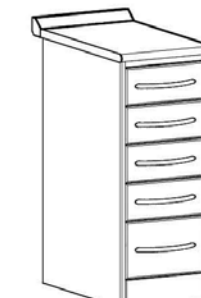

CM 8 -35
L. 370

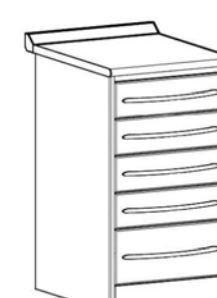

CM 8 -50
L. 520

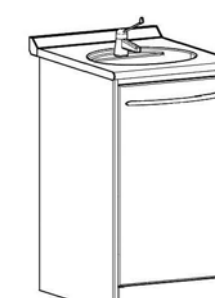

CML/C
L. 520

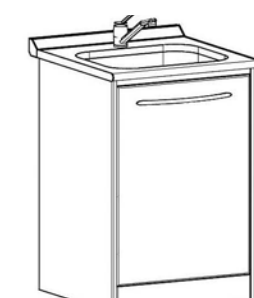

CML/G60
L. 620

BANCHI

P 650 H filo piano 905 H filo alzatina 945
 P 650 H above top 905 H above channel 945

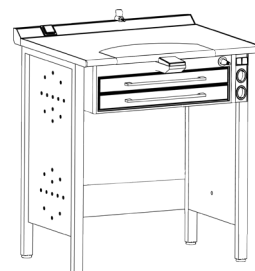

TEC1D
 L. 810

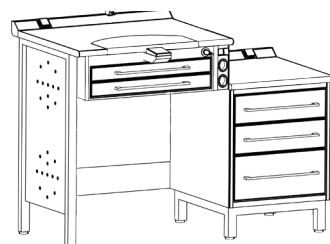

TEC1D-TM2
 L.1270

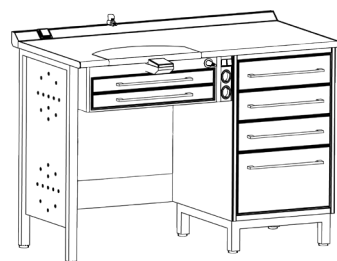

TEC101D
 L.1270

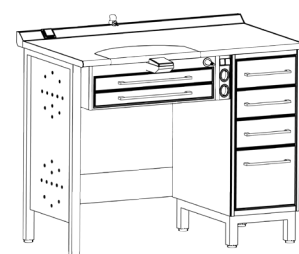

TEC101D-35
 L.1120

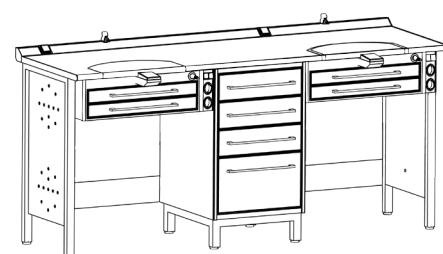

TEC201D
 L.2020

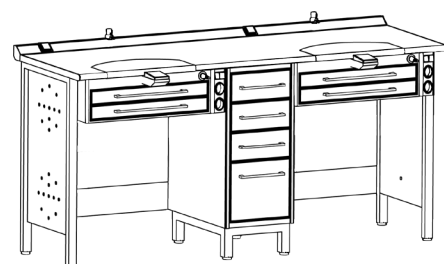

TEC201D-35
 L.1870

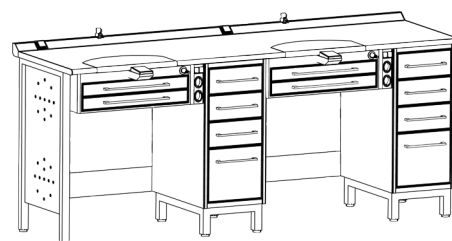

TEC301D-35
 L.2180

CASSETTIERE



TM1
 L.520



TM1-35
 L.370



TM2
 L.520

BANCHI

P 650 H filo piano 905 H filo alzatina 945
 P 650 H above top 905 H above channel 945



BLEK
L. 660



BLEK1
L. 750

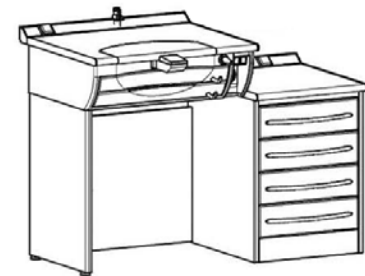

BLEK1-CM2
L. 1250



BLEK101
L. 1250



BLEK101-35
L. 1100

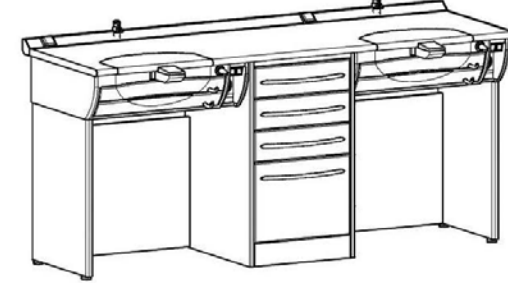

BLEK201
L. 1980

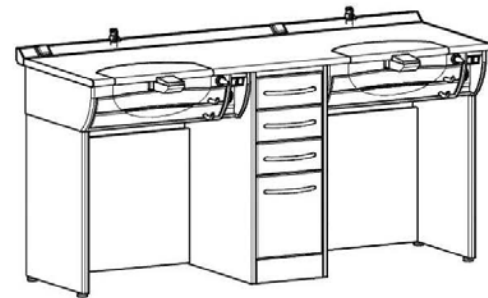

BLEK201-35
L. 1830

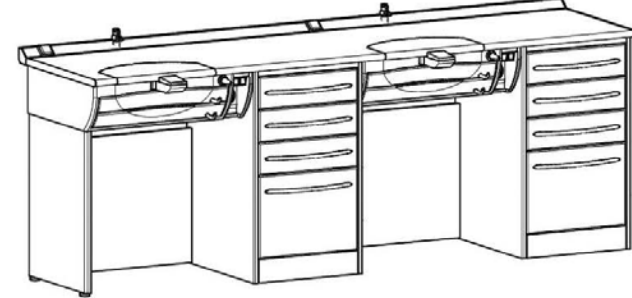

BLEK301
L. 2480

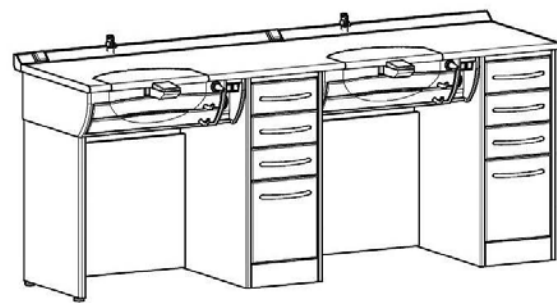

BLEK301-35
L. 2180

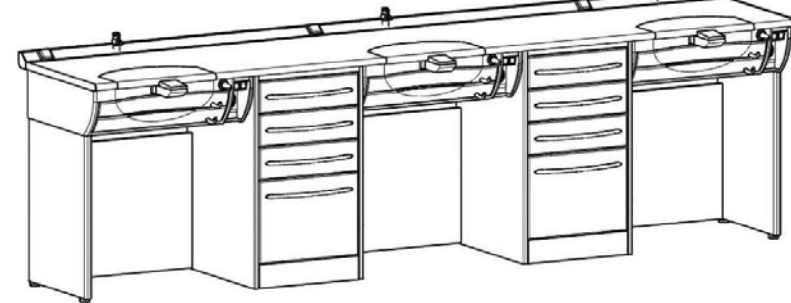

BLEK303
L. 3210

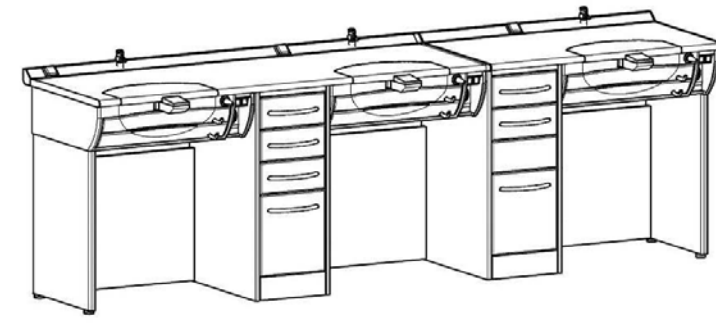

BLEK303-35
L. 2910

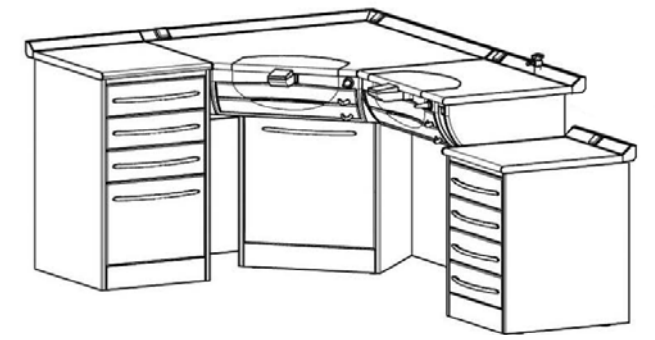

BLEK-CER
L. 1590/2320

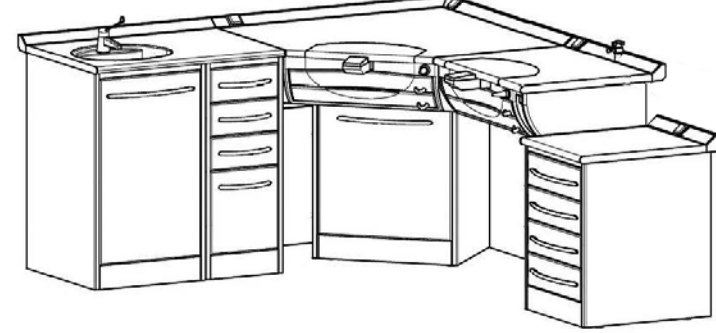

BLEK-CER1
L. 1940/2320



BLEKMA
L. 1080/1080

CASSETTIERE

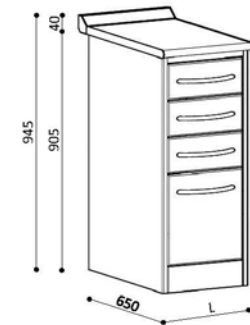

CM1-35
L. 370



CM1-50
L. 520

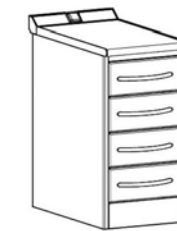

CM2-35
L. 370 H. 700



CM2-50
L. 520 H. 700



CM3-50
L. 520

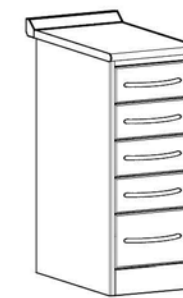

CM8-35
L. 370

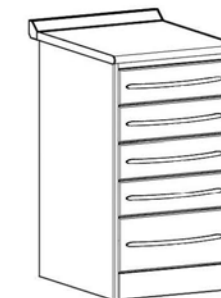

CM8-50
L. 520



CML/C
L. 520

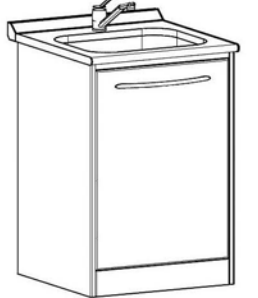

CML/G60
L. 620

BANCHI

P 650 H filo piano 905 H filo alzatina 945
P 650 H above top 905 H above channel 945



SKY1D
L.830

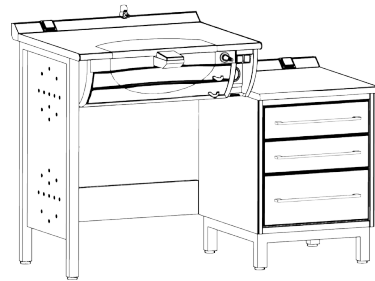

SKY1D-TM2
L.1290

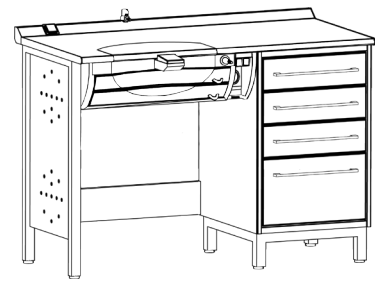

SKY101D
L.1290

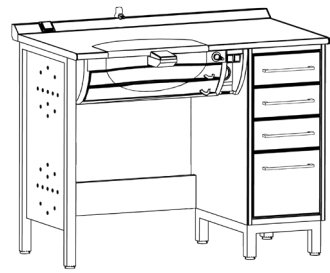

SKY101D-35
L.1140

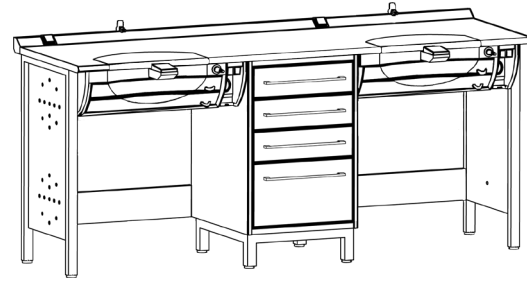

SKY201D
L.2060

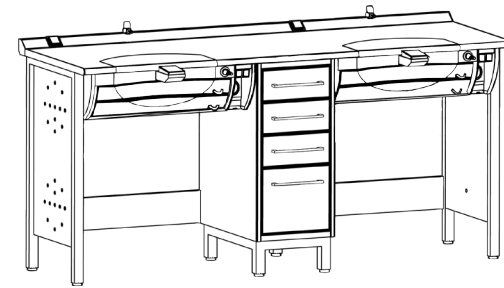

SKY201D-35
L.1910

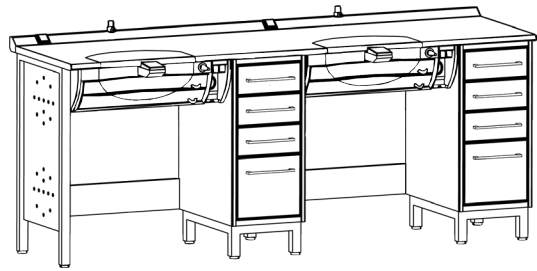

SKY301D-35
L.2220

CASSETTIERE



TM1
L.520



TM1-35
L.370



TM2
L.520

BANCHI

P 650 H filo piano 905 H filo alzatina 945
 P 650 H above top 905 H above channel 945



BLS1
L. 1010



BLS1/PS
L. 1010

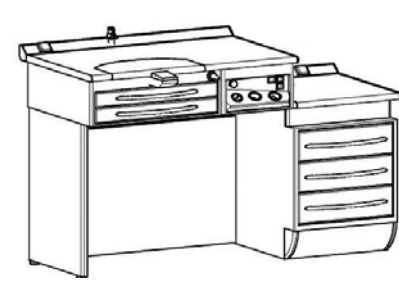

BLS1-CM2
L. 1510



BLS1/PS-CM2
L. 1510

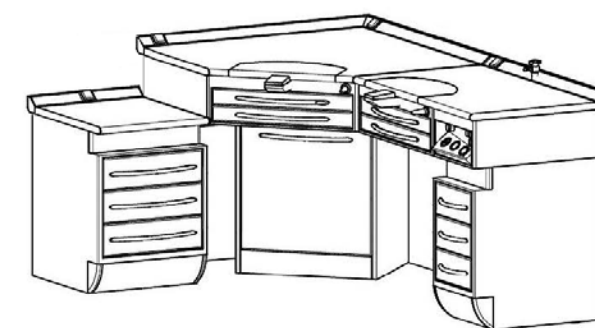

BLS-CER
L. 1590/2080

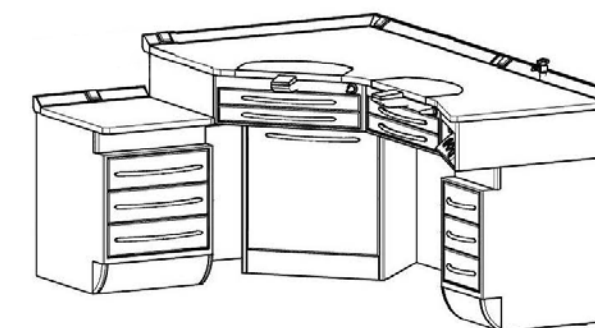

BLS-CER/PS
L. 1590/2080

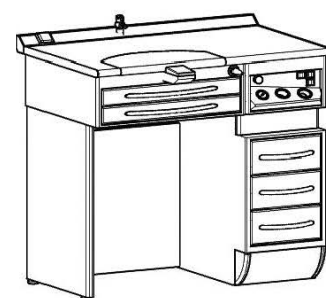

BLS135
L. 1010

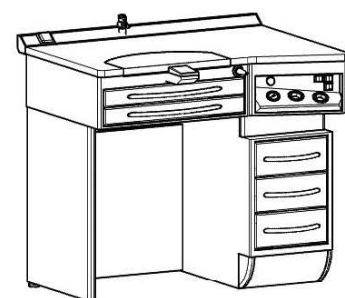

BLS135/PS
L. 1010

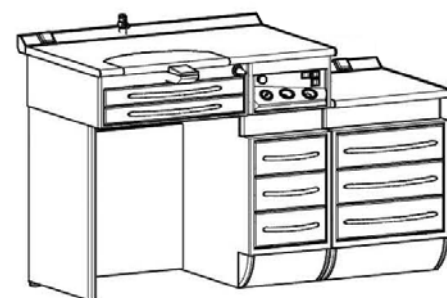

BLS135-CM2
L. 1510

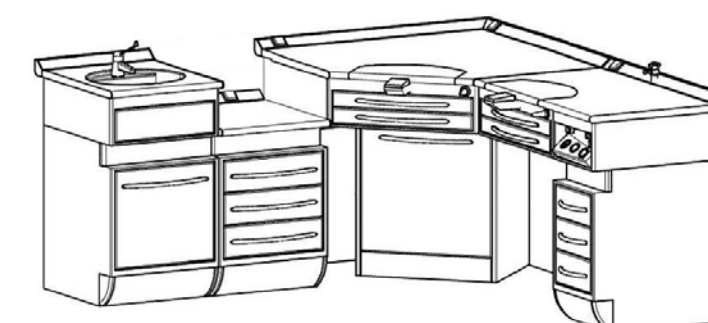

BLS-CER1
L. 2090/2080

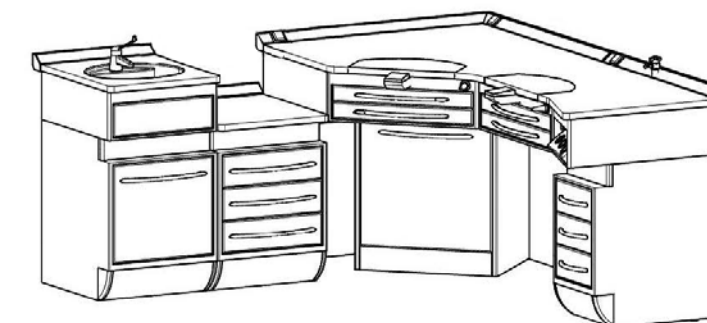

BLS-CER1/PS
L. 2090/2080



BLS135/PS-CM2
L. 1510

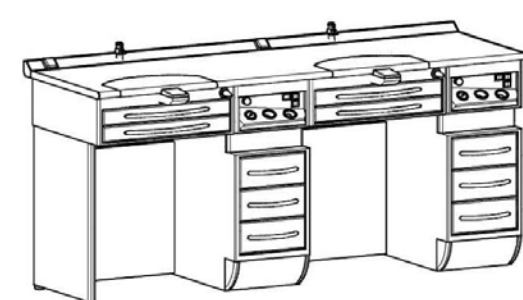

BLS235
L. 2000

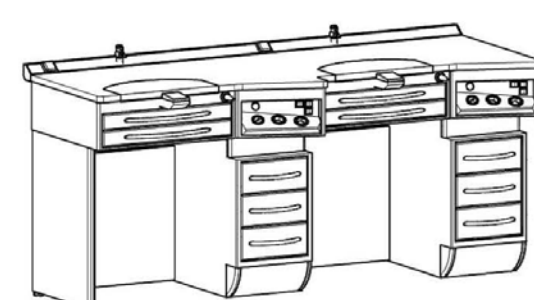

BLS235/PS
L. 2000

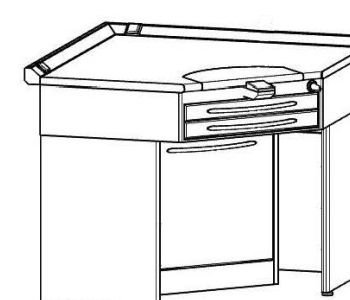

BLMA
L. 1080/1080

CASSETTIERE

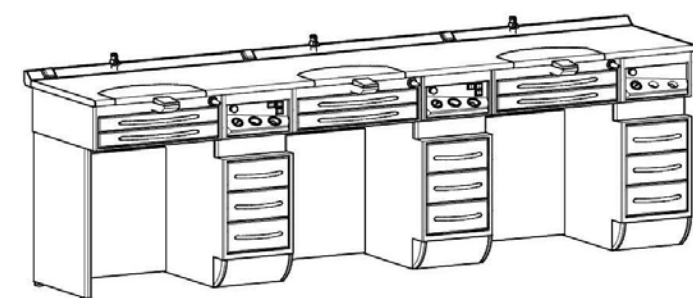

BLS335
L. 2990

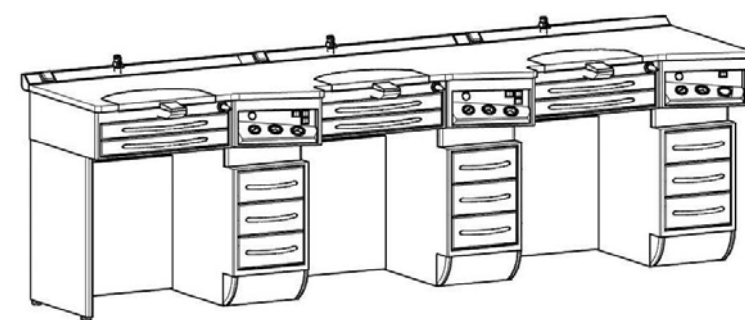

BLS335/PS
L. 2990

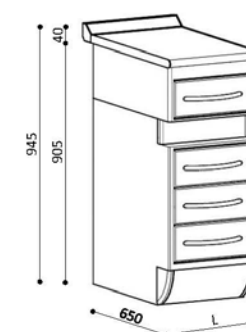

CM4/AM35
L.370

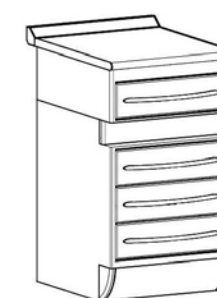

CM4/AM50
L.520

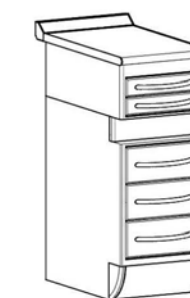

CM5/AM35
L.370

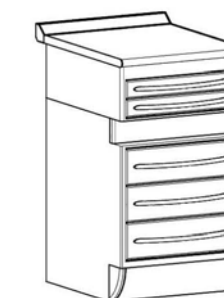

CM5/AM50
L.520

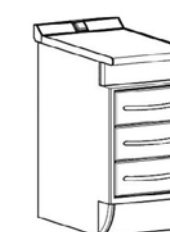

CM2/ET35
L.370 H.700



CM2/ET50
L.520 H.700



CML/AMC
L.520

BANCHI

P 650 H filo piano 905 H filo alzatina 945
 P 650 H above top 905 H above channel 945

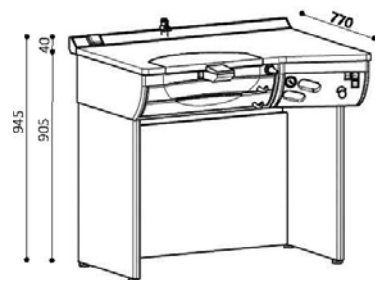

BLET1
L.1010

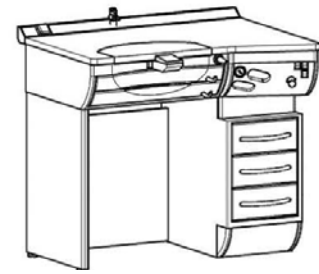

BLET135
L.1010

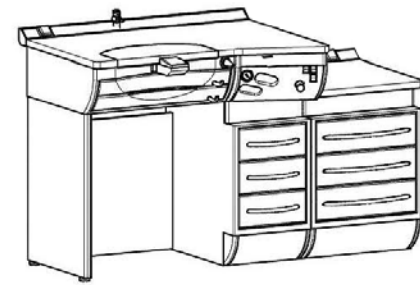

BLET135-CM2
L.1510

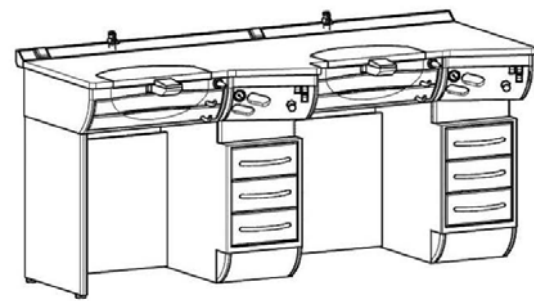

BLET235
L.2000

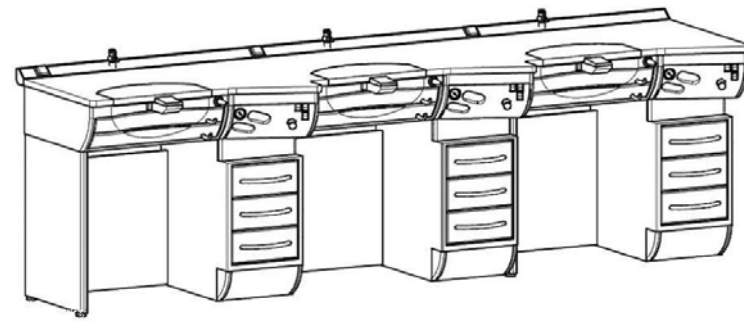

BLET335
L.2990

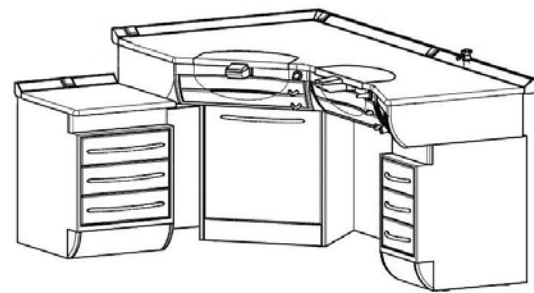

BLET-CER
L.1590/2080

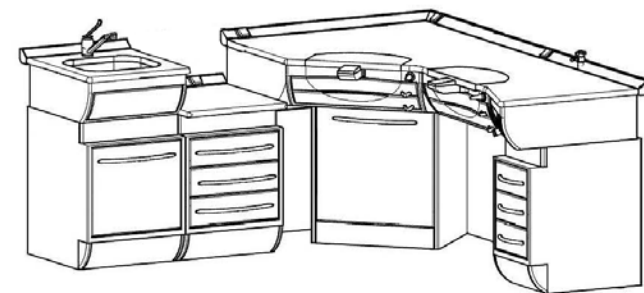

BLET-CER1
L.2090/2080



BLEKMA
L.1080/1080

CASSETTIERE

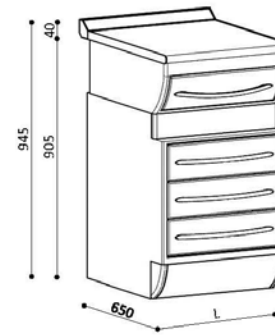

CM4/ET50
L.520



CML/ETC
L.520

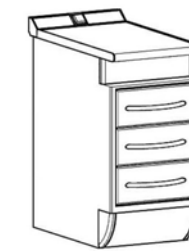

CM2/ET35
L.370 H.700



CM2/ET50
L.520 H.700

MOBILI DI SERVIZIO

P 650 H filo piano 905 H filo alzatina 945
 P 650 H above top 905 H above channel 945

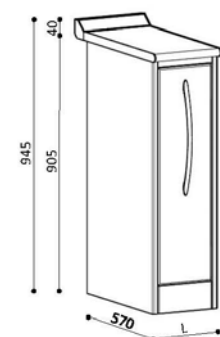

MS1-25/900
L.270

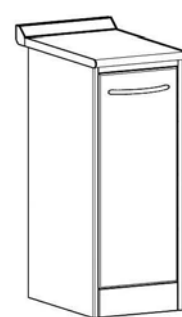

MS1-35/900
L.370

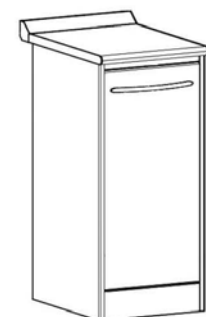

MS1-40/900
L.420

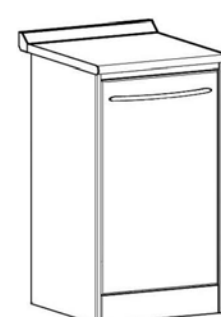

MS1/900
L.520

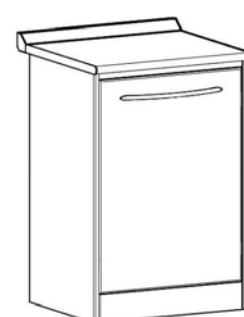

MS1-60/900
L.620



MDS/900
L.520



MDSG/900
L.620



MDS1 DX/900
L.1020



MDS1 SX/900
L.1020

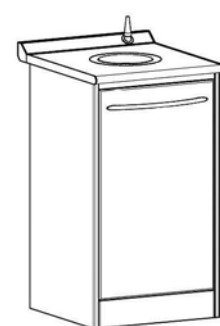

MS1G/900
L.520

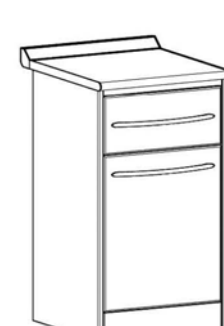

MS2/900
L.520



MS3G/900
L.520

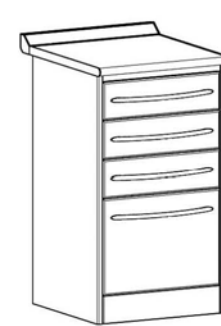

MS4/900
L.520

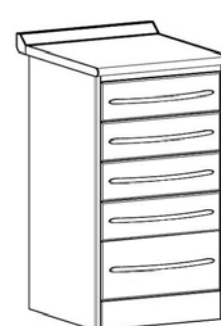

MS5/900
L.520



MDS2/900
L.1020



MTS1/900
L.1520

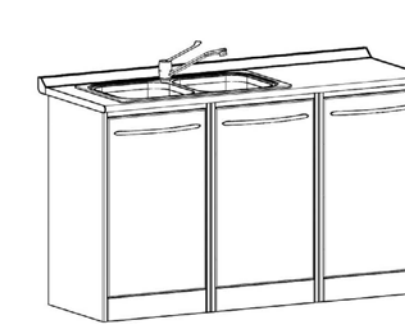

MTS2/900
L.1520

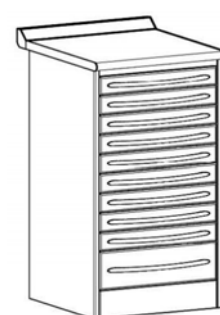

MS10/900
L.520



MD2/900
L.1020



MD4/900
L.1020



MD4G/900
L.1020

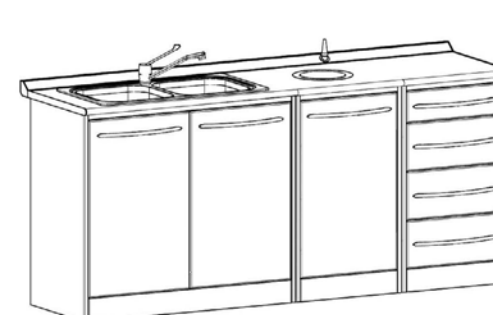

MTS2-3G/900
L.2020



MTS2-3G/1000
L.2020 H.1000

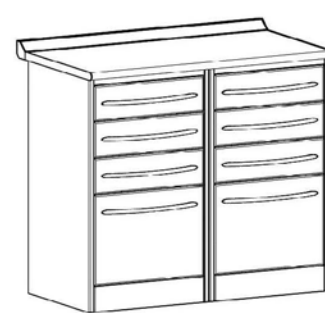

MD8/900
L.1020

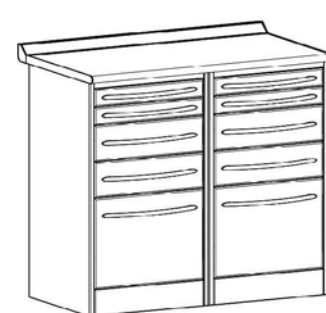

MD10/900
L.1020



MT6/900
L.1520

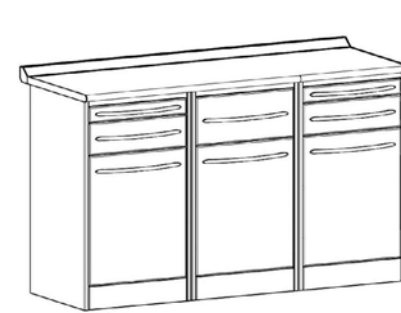

MT8/900
L.1520

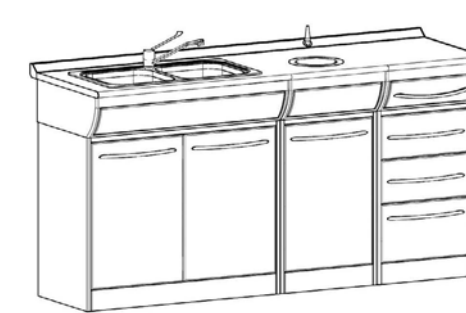

MTS2-3G/1050
L.2020 H.1035



MLA-I/900
L.840/840



MLA-IG/900
L.840/840



MA/900
L.840/840

MOBILI DI SERVIZIO

P 650 H filo piano 905 H filo alzatina 945
 P 650 H above top 905 H above channel 945



TS1
L.520



TS2
L.520



TS4
L.520



TS5
L.520



TDS2
L.1020

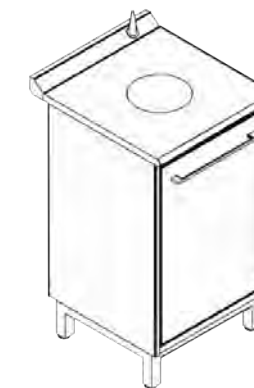

TS1G
L.520



TD4G
L.1020



TS10
L.520



MS3G
L.520



TD2
L.1020



TD4
L.1020

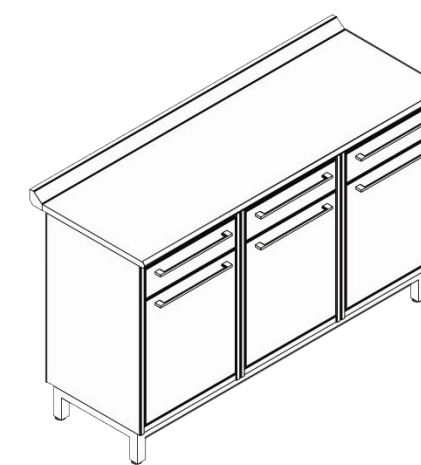

TT6
L.1520

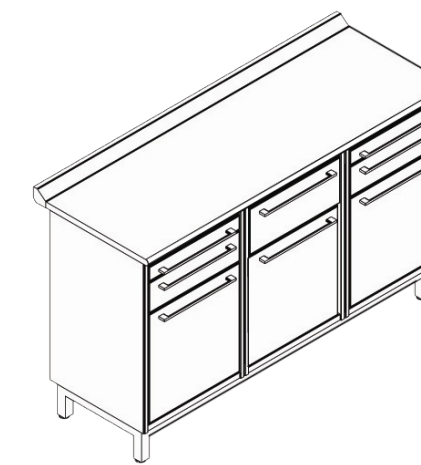

TT8
L.1520

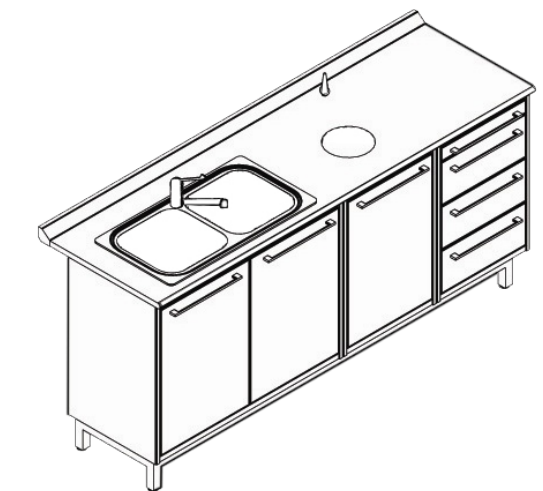

TTS23G
L.2020



TD8
L.1020



TD10
L.1020



TA
L.840



TDS
L.520



TDS1DX
L.1020

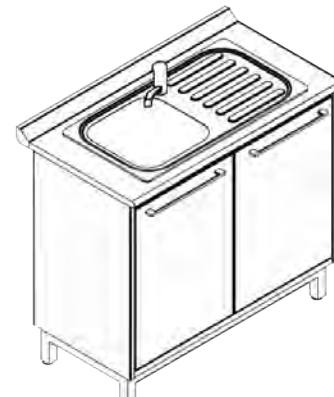

TDS1SX
L.1020

CAPPE

P 800 H 2110

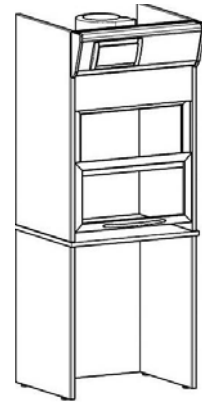

C3/R
L.810 H.2110 P.800



C3/A1S
L.810 H.2110 P.800



C3/C2S
L.810 H.2110 P.800

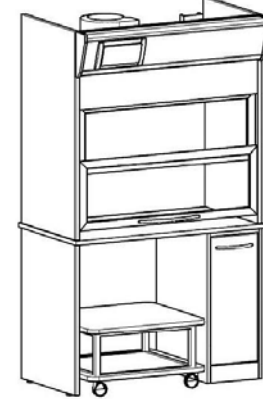

C2/RS
L.1210 H.2110 P.800

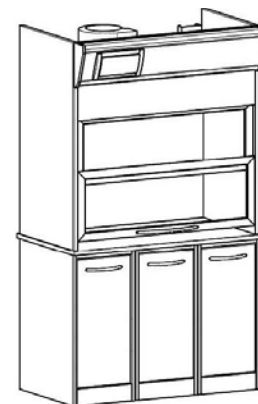

C2/A2S
L.1210 H.2110 P.800



C2/A1C2S
L.1210 H.2110 P.800

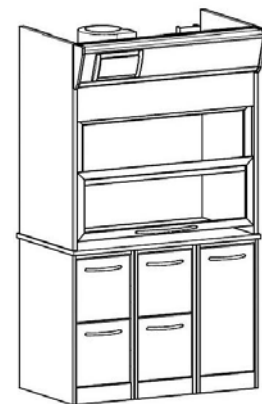

C2/C4S
L.1210 H.2110 P.800

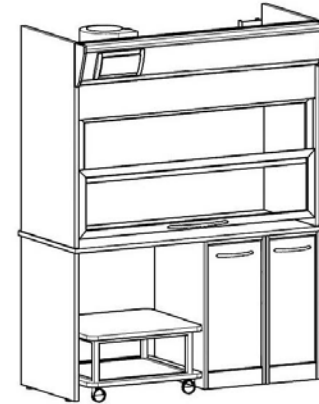

C1/RA1S
L.1610 H.2110 P.800

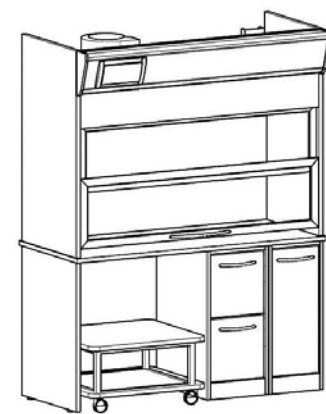

C1/RC2S
L.1610 H.2110 P.800

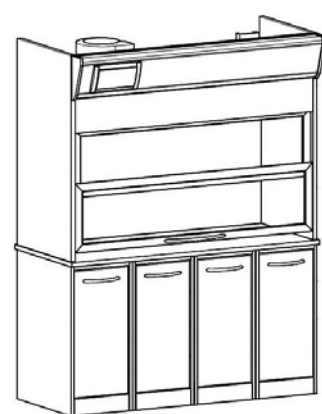

C1/A3S
L.1610 H.2110 P.800

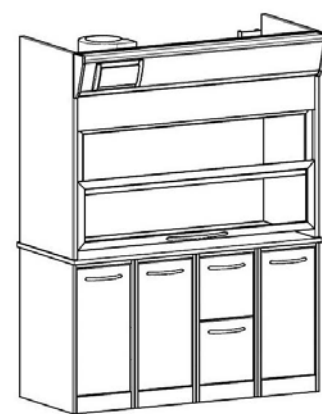

C1/A2C2S
L.1610 H.2110 P.800

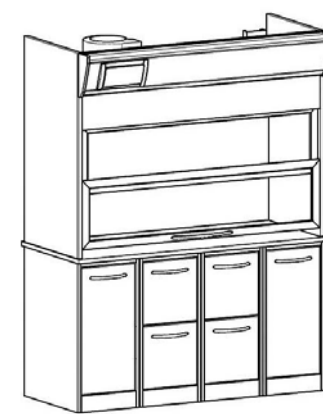

C1/A1C4S
L.1610 H.2110 P.800

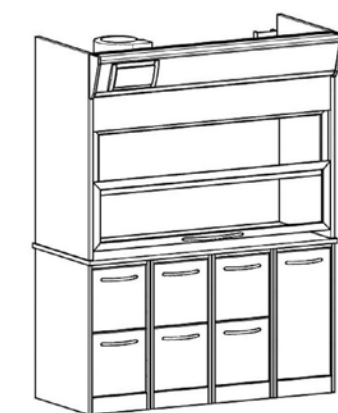

C1/C6S
L.1610 H.2110 P.800

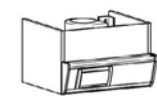

C3PX
L.800 H.500 P.800



C2PX
L.1200 H.500 P.800

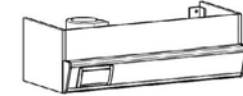

C1PX
L.1600 H.500 P.800

BOX CERAMICA

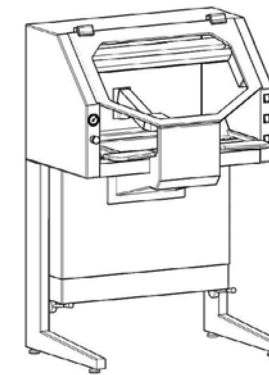

BOX CERAMICA
L.840 H.1330 P.670

MINI BOX

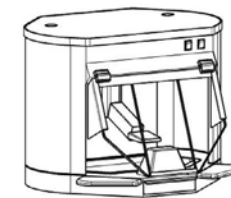

MINI BOX
L.710 H.550 P.620



TMXC
L.730 H.840 P.650

CAPPETTE

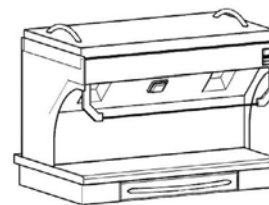

CAPPETTA
L.750 H.585 P.520



TMXC
L.750 H.840 P.650

IRIDE International srl
Via San Giuseppe 5
33082 Azzano Decimo (PN) Italy
Tel 0434/633242 Fax 0434/632546
www.irideinternational.com
welcome@irideinternational.com

IRIDE.